

# CA and CB Series Multiport Serial Module User's Manual

---

Version 8.2, December 2019

[www.moxa.com/product](http://www.moxa.com/product)

**MOXA**<sup>®</sup>

© 2019 Moxa Inc. All rights reserved.

# CA and CB Series Multiport Serial Module User's Manual

The software described in this manual is furnished under a license agreement and may be used only in accordance with the terms of that agreement.

## Copyright Notice

© 2019 Moxa Inc. All rights reserved.

## Trademarks

The MOXA logo is a registered trademark of Moxa Inc.  
All other trademarks or registered marks in this manual belong to their respective manufacturers.

## Disclaimer

Information in this document is subject to change without notice and does not represent a commitment on the part of Moxa.

Moxa provides this document as is, without warranty of any kind, either expressed or implied, including, but not limited to, its particular purpose. Moxa reserves the right to make improvements and/or changes to this manual, or to the products and/or the programs described in this manual, at any time.

Information provided in this manual is intended to be accurate and reliable. However, Moxa assumes no responsibility for its use, or for any infringements on the rights of third parties that may result from its use.

This product might include unintentional technical or typographical errors. Changes are periodically made to the information herein to correct such errors, and these changes are incorporated into new editions of the publication.

## Technical Support Contact Information

[www.moxa.com/support](http://www.moxa.com/support)

### **Moxa Americas**

Toll-free: 1-888-669-2872  
Tel: +1-714-528-6777  
Fax: +1-714-528-6778

### **Moxa Europe**

Tel: +49-89-3 70 03 99-0  
Fax: +49-89-3 70 03 99-99

### **Moxa India**

Tel: +91-80-4172-9088  
Fax: +91-80-4132-1045

### **Moxa China (Shanghai office)**

Toll-free: 800-820-5036  
Tel: +86-21-5258-9955  
Fax: +86-21-5258-5505

### **Moxa Asia-Pacific**

Tel: +886-2-8919-1230  
Fax: +886-2-8919-1231

# Table of Contents

<b>1. Introduction</b> .....	<b>1-1</b>
Overview .....	1-2
Package Checklist .....	1-2
Product Specifications .....	1-3
<b>2. Hardware Installation</b> .....	<b>2-1</b>
Hardware Installation .....	2-2
Block Diagrams .....	2-2
I/O Base Address (For CA Series) .....	2-4
Rotary Switch (For CB Series) .....	2-5
Termination Resistor .....	2-5
Interrupt Vector for CA Series .....	2-5
Serial Interface .....	2-6
<b>3. Software Installation</b> .....	<b>3-1</b>
Windows OS .....	3-2
Older OS for CA Series .....	3-2
Older OS for CB Series .....	3-21
Newer OS for Both CA/CB Series .....	3-45
Non-Windows OS .....	3-61
<b>4. Serial Programming Tools</b> .....	<b>4-1</b>
Serial Programming Library .....	4-2
PComm Utilities .....	4-2
Installation .....	4-2
PComm Diagnostic .....	4-2
PComm Monitor .....	4-3
PComm Terminal Emulator .....	4-3
<b>5. Smartio/Industio Programming Guide</b> .....	<b>5-1</b>
Relative Product List .....	5-2
Resource Requirement for Moxa Board .....	5-2
PCI Configuration for Moxa Board .....	5-2
UART Register Structure for MU860 chip .....	5-3
UART Register Structure for MUE250, MUE450, and MUE850 chips .....	5-4
For Baud Rate Setting .....	5-5
Moxa Board PCI Device ID List .....	5-6
UART Datasheet .....	5-6
<b>6. Pin Assignments</b> .....	<b>6-1</b>
Box Header Pin Assignments .....	6-1
RS-232 .....	6-1
RS-422, 4-wire RS-485 .....	6-1
2-wire RS-485 .....	6-2

# Introduction

---

Welcome to the CA and CB Series of PC/104 communication modules, a multiport serial module for industrial applications. It is designed for the PC/104 CPU and PC/104-Plus boards that respectively accept the PC/104 and PC/104-Plus expansion interface. Optional DB9 and DB25 cables are available to connect different devices.

The CA Series includes the following models:

<b>CA-108:</b>	8 ports, RS-232
<b>CA-108-T:</b>	8 ports, RS-232, wide temperature
<b>CA-114:</b>	4 ports, RS-232/422/485
<b>CA-114-T:</b>	4 ports, RS-232/422/485, wide temperature
<b>CA-134I:</b>	4 ports, RS-422/485, optical isolation protection
<b>CA-134I-T:</b>	4 ports, RS-422/485, optical isolation protection, wide temperature
<b>CA-104:</b>	4 ports, RS-232
<b>CA-104-T :</b>	4 ports, RS-232, wide temperature
<b>CA-132:</b>	2 ports, RS-422/485
<b>CA-132-T:</b>	2 ports, RS-422/485, wide temperature
<b>CA-132I:</b>	2 ports, RS-422/485, optical isolation protection
<b>CA-132I-T:</b>	2 ports, RS-422/485, optical isolation protection, wide temperature

The CB Series includes the following models:

<b>CB-108:</b>	8 ports, RS-232
<b>CB-108-T:</b>	8 ports, RS-232, wide temperature
<b>CB-114:</b>	4 ports, RS-232/422/485
<b>CB-114-T:</b>	4 ports, RS-232/422/485, wide temperature
<b>CB-134I:</b>	4 ports, RS-422/485, optical isolation protection
<b>Cb-134I-T:</b>	4 ports, RS-422/485, optical isolation protection, wide temperature

2 kV optical isolation is provided on optical isolation models. Wide-temperature models are rated for operation between -40 to 85°C.

The following topics are covered in this chapter:

- **Overview**
- **Package Checklist**
- **Product Specifications**

## Overview

The PC/104 standard serial boards are very popular for embedded applications. Moxa offers a wide selection of PC/104 and PC/104-Plus serial boards to provide industrial-grade connections to multiple serial devices.

Use Moxa's serial boards so that your PC/104-based systems can establish serial device connections with high data throughput over multiple serial interfaces. The CA serial board series is for PC/104 modules, while the CB serial board series is for PC/104-Plus modules.

## Package Checklist

MOXA performs a careful mechanical and electrical inspection of each module prior to shipping. Your module should arrive in perfect electrical order, free of any marks or scratches. Please handle the module by the edges only, since your body's static charge can damage the integrated circuits. When the module is not in use, please keep it in the anti-static package provided. You may also use this package to return the module if it requires repair.

The CA/CB Series module is shipped with the following items:

- Multiport serial module (PC/104 is for CA Series; PC/104-Plus is for CB Series)
- Documentation and software CD
- Quick installation guide
- 5-year product warranty statement

<b>NOTE</b> Please notify your sales representative if any of the above items are missing or damaged.
---

The CA Series module features the following:

- Two, four, or eight serial ports (depending on the model)
- RS-232, RS-422, or RS-485 operation (depending on the model)
- 64-byte FIFOs and on-chip flow control
- Up to 921.6Kbps data transmission speed
- Built-in 15 KV ESD protection
- Configurable IRQ and I/O settings
- Onboard Tx, Rx LED indicators for each port
- Optional wide temperature support (-40 to 85°C)

The CB Series module features the following:

- Four or eight serial ports (depending on the model)
- RS-232, RS-422, or RS-485 operation (depending on the model)
- 128-byte FIFOs and on-chip flow control
- Up to 921.6Kbps data transmission speed
- Built-in 15 KV ESD protection
- Onboard Tx, Rx LED indicators for each port
- Optional wide temperature support (-40 to 85°C)

# Product Specifications

**NOTE** The latest specifications for Moxa's products can be found at <https://www.moxa.com>.

## Hardware Installation

---

This chapter explains how to install the CA/CB Series multiport serial module.

The following topics are covered in this chapter:

- **Hardware Installation**
- **Block Diagrams**
  - I/O Base Address (For CA Series)
  - Rotary Switch (For CB Series)
  - Termination Resistor
  - Interrupt Vector for CA Series
- **Serial Interface**

# Hardware Installation

Installing the CA/CB Series module is easy. For the CA Series, before inserting the module into the PC/104 slot, you must first configure the I/O base address, interrupt vector, IRQ, and serial interface (for select models).



## ATTENTION

### Safety First!

To prevent damage to your system or board, make sure your embedded PC's power is turned off before installing your CA/CB Series module.

CA Series	CB Series
<p><b>Step 1:</b> Shut off power to your embedded PC and to any peripheral devices. After shutting off power, remove the cover of your embedded PC.</p> <p><b>Step 2:</b> Use the DIP switches on the module to select the I/O base address, interrupt vector, IRQ, and serial interface (for select models). Details for each model are provided later in this chapter.</p> <p><b>Step 3:</b> Insert the module firmly into the embedded PC's PC/104 slot.</p> <p><b>Step 4:</b> Screw the control board in place</p> <p><b>Step 5:</b> Connect the cables.</p> <p><b>Step 6:</b> Power on the embedded PC.</p>	<p><b>Step 1:</b> Shut off power to your embedded PC and to any peripheral devices. After shutting off power, remove the cover of your embedded PC.</p> <p><b>Step 2:</b> Use the DIP switches on the module to select the serial interface. Details for each model are provided later in this chapter.</p> <p><b>Step 3:</b> Insert the module firmly into the embedded PC's PC/104-Plus slot.</p> <p><b>Step 4:</b> Screw the control board in place.</p> <p><b>Step 5:</b> Connect the cables.</p> <p><b>Step 6:</b> Power on the embedded PC. The BIOS will automatically set the IRQ and I/O address.</p> <p><b>Step 7:</b> Proceed with the software installation. Please refer to Chapter 3.</p>

## Block Diagrams

**CA-108**

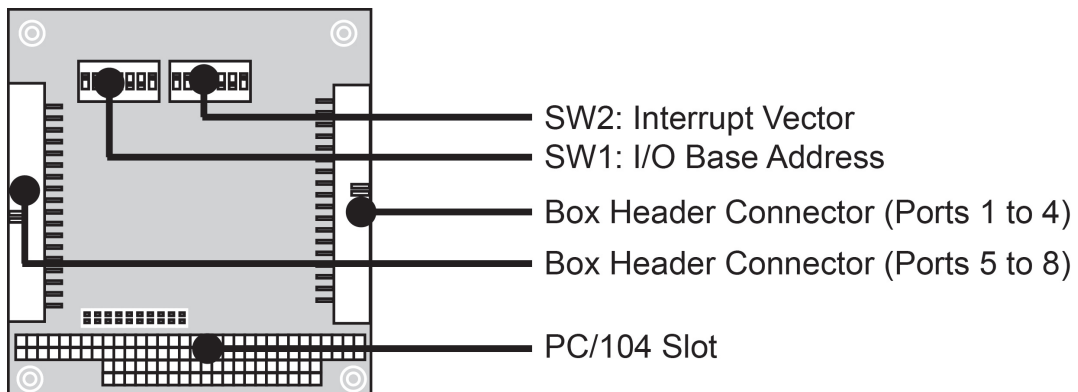



**CA-114**

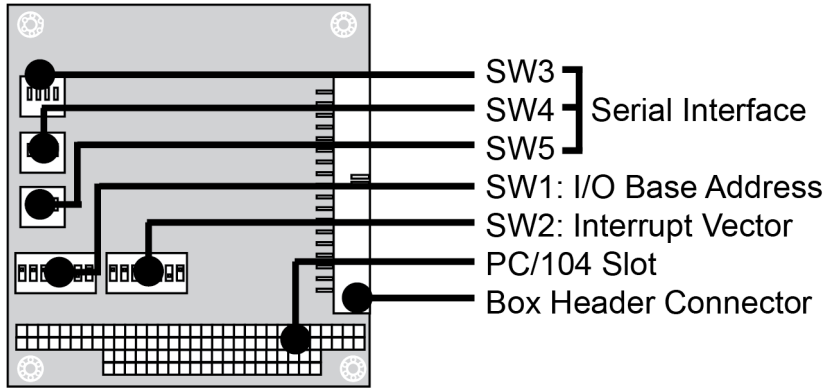

**CA-134I, CA-132, CA-132I**

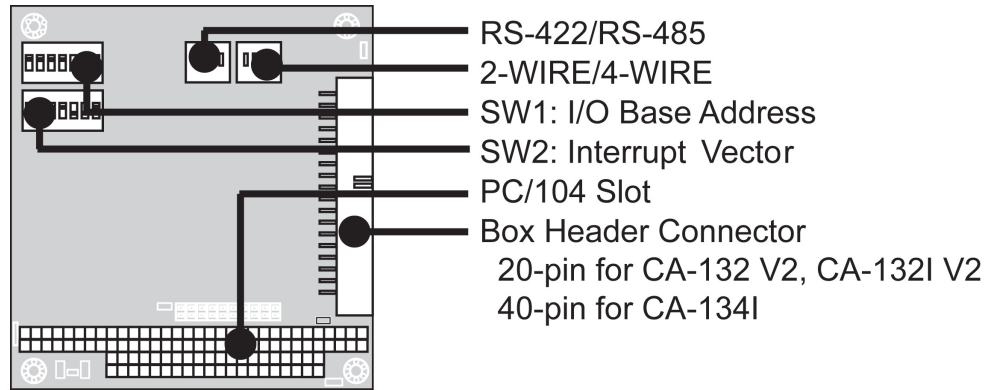

**CA-104**

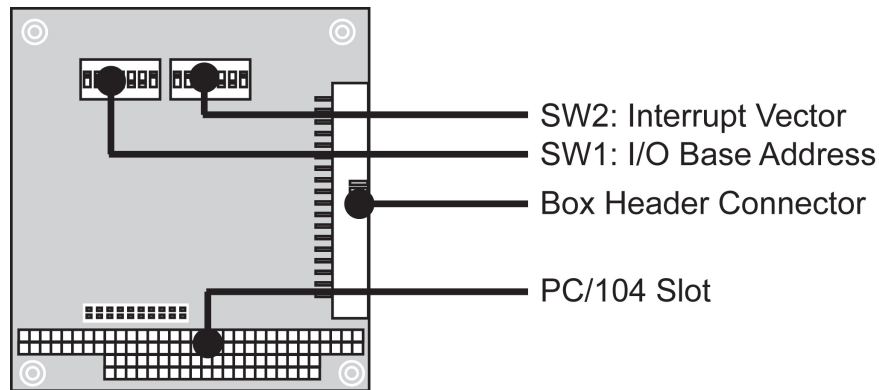

**CB-108**

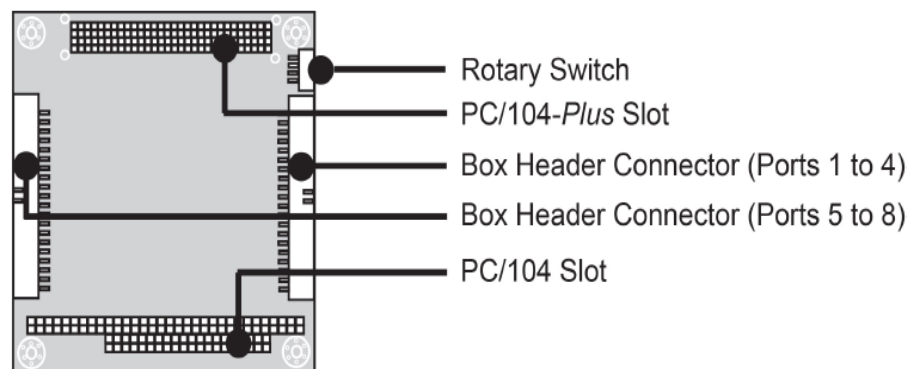

**CB-114**

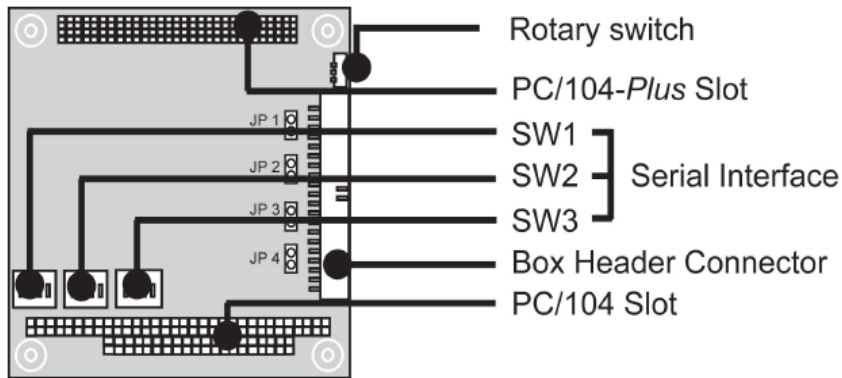

**CB-134I**

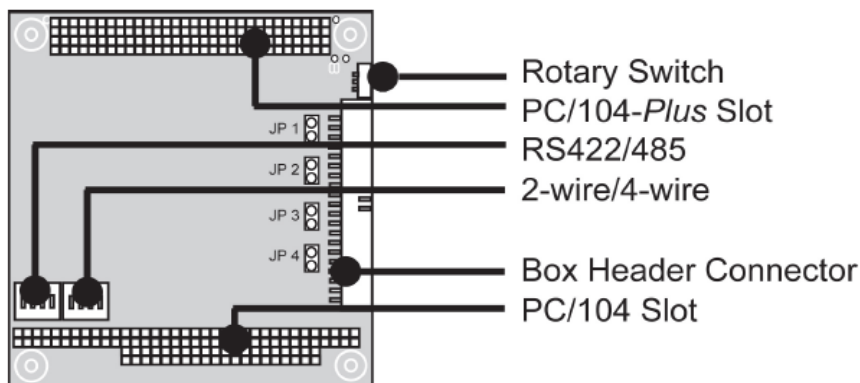

**I/O Base Address (For CA Series)**

Use DIP switch SW1 to set port 1's I/O base address. The other ports will be configured automatically. The default I/O base address is 0x180 and allows settings from 0x000 to 0x3FF. Some popular settings are provided below:

A3	A4	A5	A6	A7	A8	A9	Hex
8	1	2	4	8	1	2	Hex
ON	ON	ON	ON	ON	ON	ON	0x000
ON	ON	ON	ON	ON	ON	off	0x200
ON	ON	ON	ON	ON	off	off	0x300
ON	ON	ON	ON	off	off	off	0x380
ON	ON	ON	off	off	off	off	0x3C0
ON	ON	off	off	off	off	off	0x3E0
ON	off	off	off	off	off	off	0x3F0
off	off	off	off	off	off	off	0x3F8
off	ON	ON	ON	ON	ON	ON	0x008
off	off	ON	ON	ON	ON	ON	0x018
off	off	off	ON	ON	ON	ON	0x038
off	off	off	off	ON	ON	ON	0x078
off	off	off	off	off	ON	ON	0x0F8
off	off	off	off	off	ON	off	0x2F8

For example, an I/O base address of 0x180 should be set as follows:

A3	A4	A5	A6	A7	A8	A9	Hex
ON	ON	ON	ON	off	off	ON	0x180

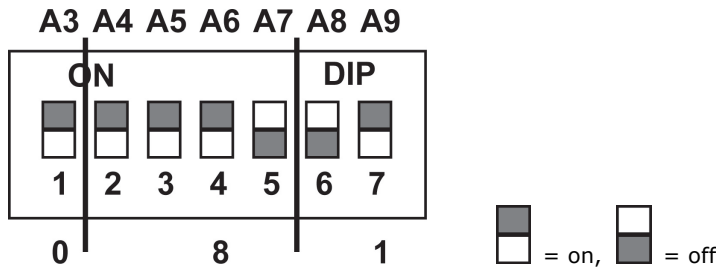

The other serial ports will be set automatically to 0x188, 0x190, 0x198, etc.

### Rotary Switch (For CB Series)

A rotary switch on the board makes it easy to set the appropriate signals, particularly when installing multiple PC/104-Plus modules in the same unit. The rotary switch, which looks like a clock, provides a bidirectional path with no signal propagation delay. The first module on the stack should be set to CLK0, the second to CLK1, etc., to eliminate clock skew between modules.

### Termination Resistor

Onboard termination resistors can be activated individually for each serial port using jumpers. With regard to the CA Series: for CA-114 and CA-134I, use JP1 through JP4; for CA-132 and CA-132I, use JP1 and JP2. JP1 corresponds to serial port 1. For the CB Series, use jumpers JP1 through JP4. JP1 corresponds to serial port 1. Short the jumper pins to activate the termination resistor; leave the jumper pins open to bypass the termination resistor.

### Interrupt Vector for CA Series

Use DIP switch SW2 to set port 1's interrupt vector. The default interrupt vector is 0x1C0, with SW2 set as follows:

A3	A4	A5	A6	A7	A8	A9	Hex
ON	ON	ON	off	off	off	ON	0x1C0

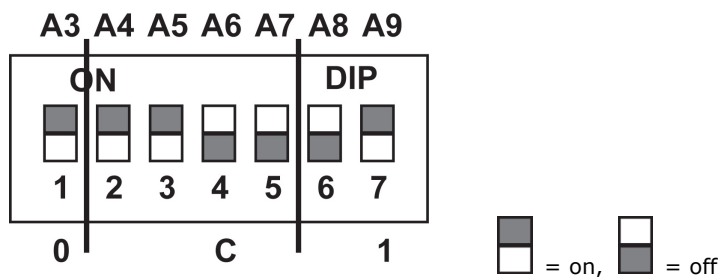

# Serial Interface

## CA Series

For the CA-114, use SW3, SW4, and SW5 to select the serial interface as follows:

Interface	RS-232	RS-422	4w RS-485	2w RS-485
SW3	-	-	ON	OFF
SW4	-	ON	OFF	OFF
SW5	ON	OFF	OFF	OFF

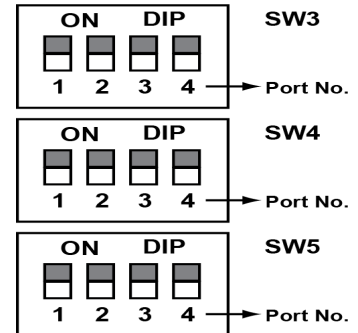

For the CA-134I, CA-132, and CA-132I, use the 2-WIRE/4-WIRE and RS-422/RS-485 DIP switches to select the serial interface as follows:

Interface	2-WIRE/4-WIRE	RS-422/RS-485
RS-422	-	OFF
4-wire RS-485	OFF	ON
2-wire RS-485	ON	ON

## CB Series

For the CB-114 and CB-134I, use the DIP switch to select serial interface.

### CB-114

Mode	S1	S2	S3
RS-232	-	-	ON
RS-422	-	ON	OFF
4-wire RS-485	ON	OFF	OFF
2-wire RS-485	OFF	OFF	OFF

### CB-134I

Mode	S1	S2
RS-422	-	OFF
4-wire RS-485	OFF	ON
2-wire RS-485	ON	ON

## IRQ for CA Series

Before selecting an IRQ, please enter the PC's BIOS and reserve a dedicated IRQ for the module. On the module, the IRQ is set by a jumper. Before inserting the module into the PC/104 slot, use the jumper to select an IRQ (3, 4, 5, 6, 7, 9, 10, 11, 12, or 15).

## Software Installation

---

After installing the CA/CB Series module in your embedded computer, the next step is installing the software. Drivers for various operating systems are provided, including DOS, Windows, and Linux. This chapter explains how to install and remove the CA/CB Series driver.

The following topics are covered in this chapter:

### ❑ **Windows OS**

- Older OS for CA Series
- Older OS for CB Series
- Newer OS for Both CA/CB Series

### ❑ **Non-Windows OS**

# Windows OS

## Older OS for CA Series

### DOS

Moxa DOS API-232 is a software package that can help you develop or debug serial communications programs. This section will explain how to install the package, set up the driver, and load or unload the driver. For additional information about the API-232 library and utilities, please refer to Chapter 4.

The DOS drivers support the CA-104, CA-104-T, CA-132, CA-132-T, CA-132I, and CA-132I-T. The CA-108, CA-114, and CA-134I models are not supported under DOS.

In the following instructions, the CA-104 is used as an example.

### Installing the Driver

Run the installation program, **DOSINST.EXE**, in the DOS folder. Specify the target directory for the API-232 files (e.g., **C:\MOXA**). Press **F2** to start the installation.



When the installation is completed, you will be prompted to set up the board and driver initial values. We strongly recommend that you do so.



### Driver Setup

The following instructions are not intended to illustrate every function of the setup program. For more detailed information, please refer to the help files by pressing F1 in the setup program.

1. Run the setup program **BIN\SETUP.EXE**.
2. Select your CA Series model and press **Enter**.



3. You must set the Port No., I/O Address, IRQ, and INT Vector properly. These settings must match your module's hardware configuration.



4. Press **PgDn** to view advanced the port setup options. Your module's configuration will be displayed along with other settings, such as port number, buffer size, etc.

5. Verify the settings and make any necessary changes.



- Port number:** This is the port ID of each port. Application software will refer to a port by its port number (ID). Port numbers must be unique; duplicated port numbers are not allowed. The port ID can range from 0 to 127 as long as it does not overlap with another port. Generally, you should consider the convenience of programming when specifying the port number.
- TxD buffer size:** This is the transmission (output) buffer allocated in the system for each port.
- RxD buffer size:** This is the receiving (input) buffer allocated in the system for each port.
- F5: Group Edit:** This allows you to configure several ports simultaneously as a group.

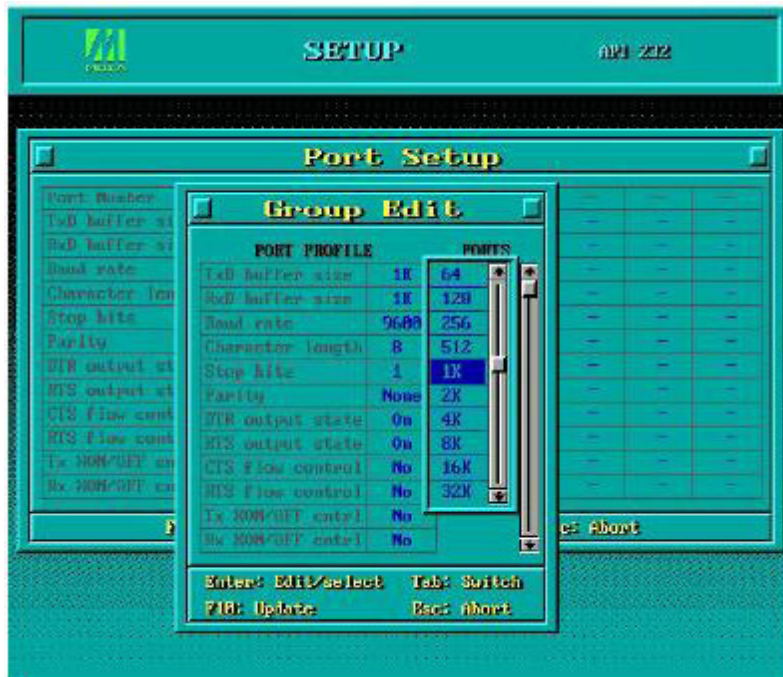

6. Press **F10** to save the latest configuration and exit the setup program.



## Loading the Driver

After setting up the driver, you must load the driver in order to gain access to the serial ports on the module. Run **BIN\DPC-DRV.EXE** at the DOS prompt. The driver will detect your CA Series module automatically. You should see messages indicating successful detection of your module, such as the following:

```
PC/104 Communication Module DOS driver Version 1.0
Setup driver ...
CA-104 series OK!
Device driver setup O.K.
```

At this point, you can execute applications that support API-232 functions, or start developing applications using the API-232 library.

## Unloading the Driver

To unload or release the CA Series driver from memory, enter **DPC-DRV/Q** at the DOS prompt.

## Windows NT

The Windows NT drivers conform to the Win32 COMM API standard and support the CA-104, CA-104-T, CA-132, CA-132-T, CA-132I, CA-132I-T, CA-108, CA-114, and CA-134I.

In the following instructions, the CA-104 is used as an example.

## Installing the Driver

1. Right-click **Network Neighborhood** and select **Properties** in the context menu.

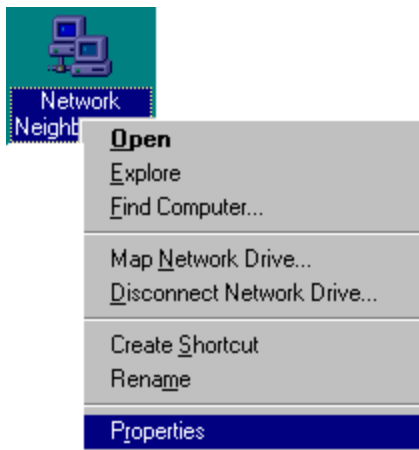

- Under the **Adapters** tab, click **Add...**.

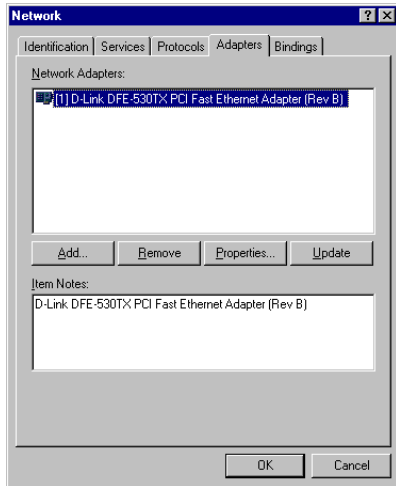

- When prompted to select a network adapter, click **Have Disk**.

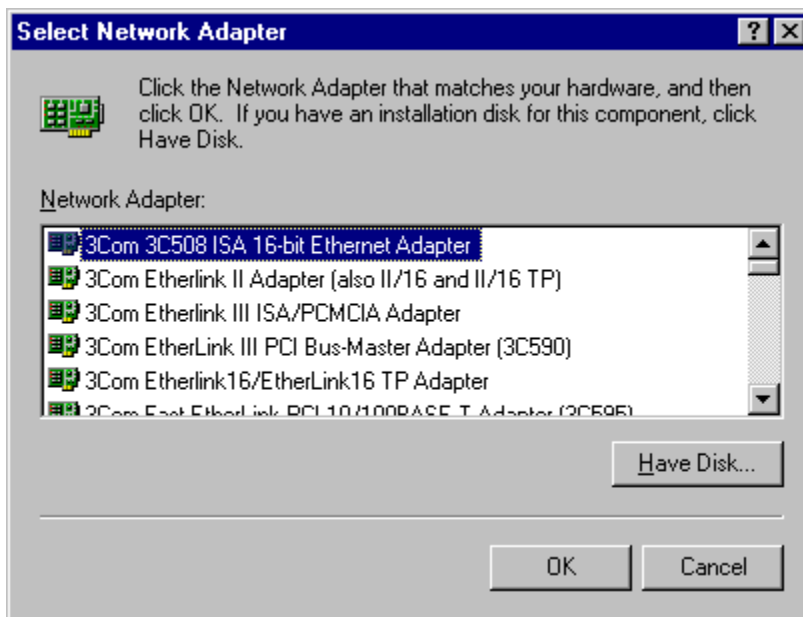

- At the prompt, insert the installation disk provided with your module.

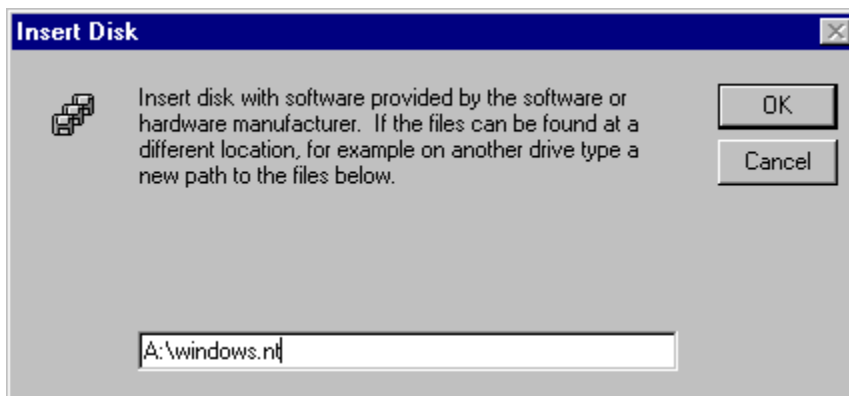

For the location, enter **A:\windows.nt**. Click **OK** to continue.

- 5. Windows will install the drivers.

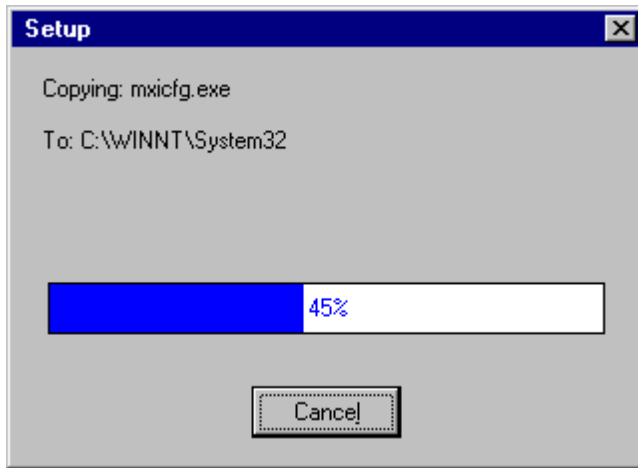

- 6. After the files have been installed, a configuration panel will open. Click **Add** to continue.

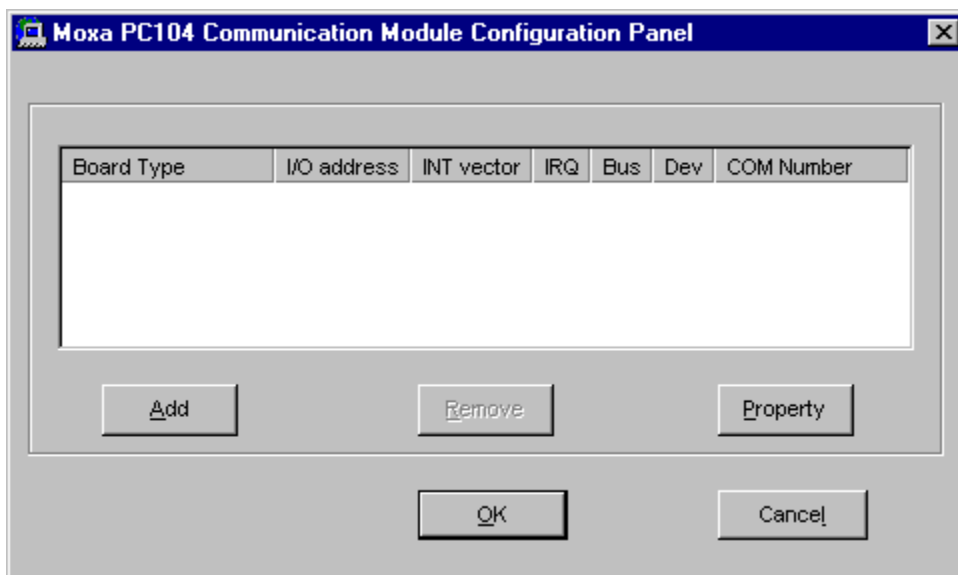

- Under **Board Type**, select your CA Series model. The window will show the COM port numbers that will be assigned to the CA Series serial ports, as well as other settings. Click **OK** to continue.

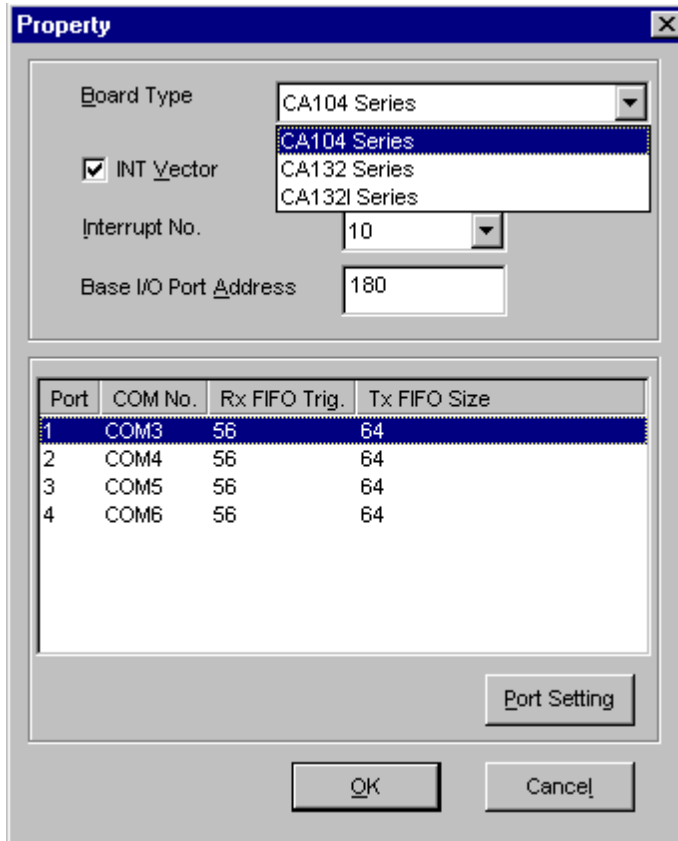

- The CA Series module will appear as a network adapter. Click **OK** to complete installation of the module.

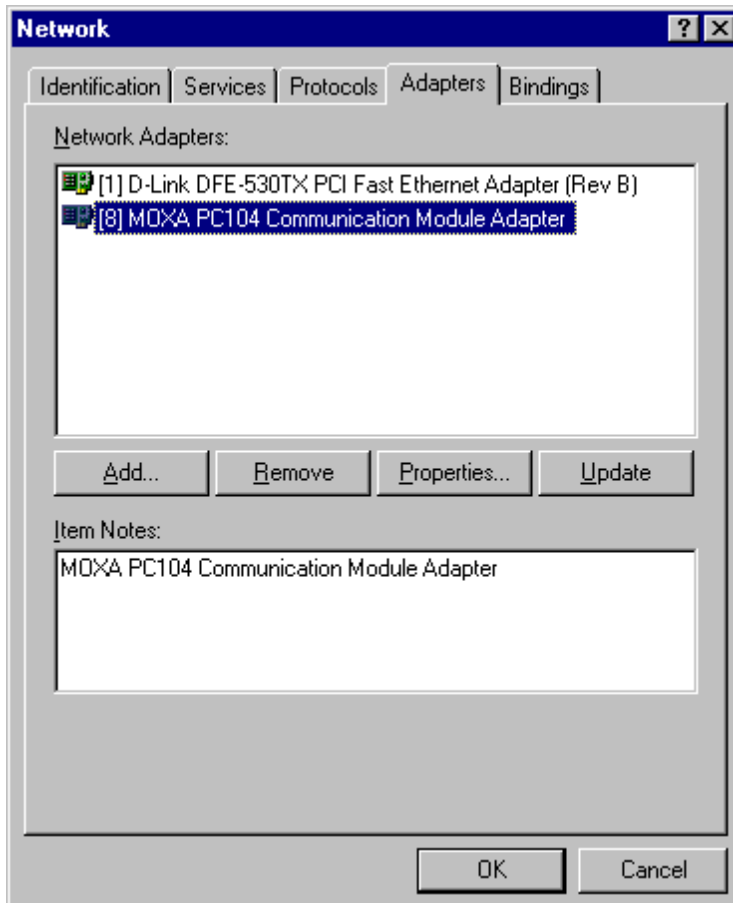

## Uninstalling the Module

1. Right-click **Network Neighborhood** and select **Properties** in the context menu.

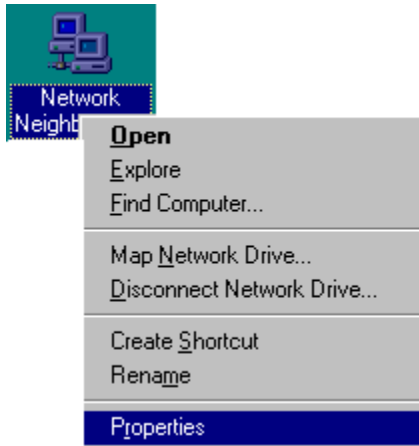

2. Under the **Adapters** tab, select your CA Series module and click **Remove**.

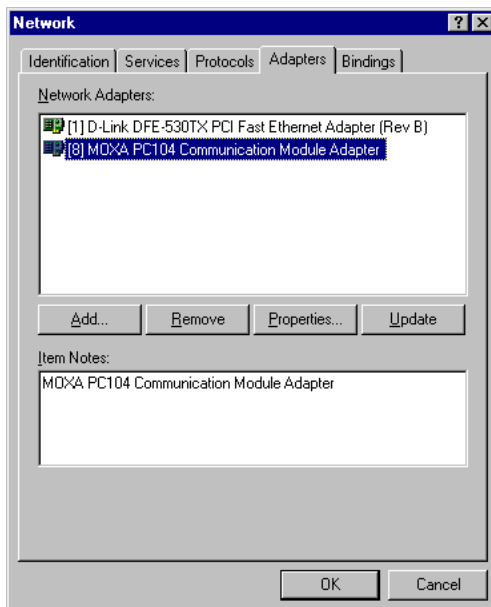

3. A confirmation dialog will appear. Click **OK** to uninstall the device.

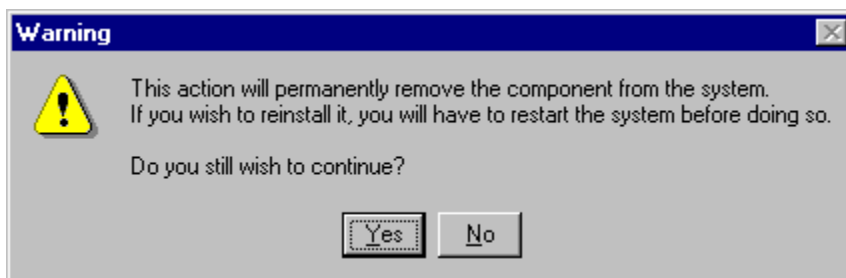

## Windows 95, 98, ME

The Windows 95/98/ME drivers conform to the Win32 COMM API standard and support the CA-104, CA-104-T, CA-132, CA-132-T, CA-132I, CA-132I-T, CA-108, CA-114, and CA-134I.

In the following instructions, the CA-104 is used as an example.

### Installing the Driver

1. Insert the CA Series installation disk and run **Setup95.exe** through **Start menu → Run**.

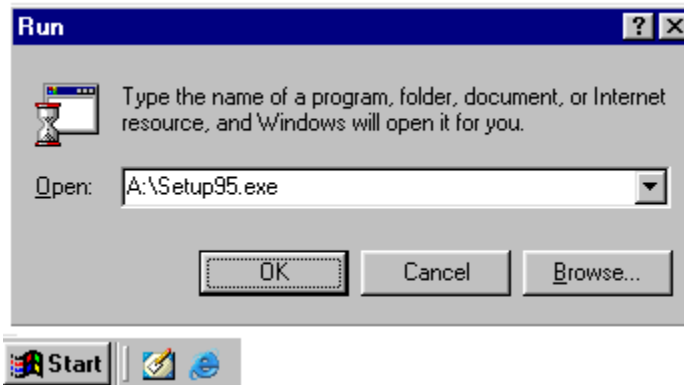

2. Click **Next** to proceed through the Welcome screens.



- Windows will install the drivers. When the installation has been completed, click **Finish**.

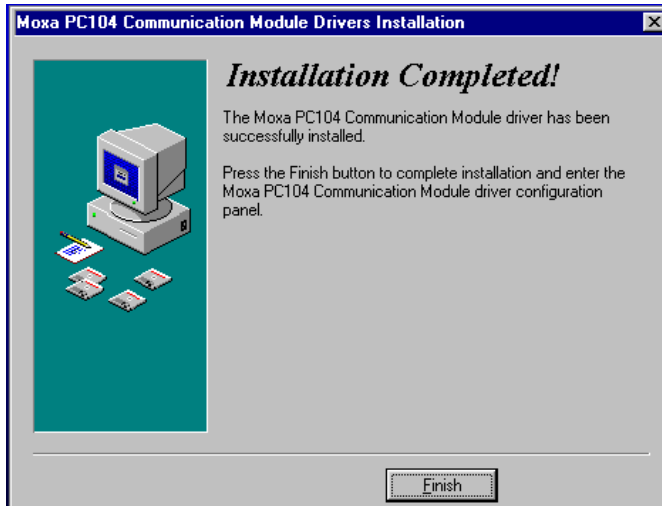
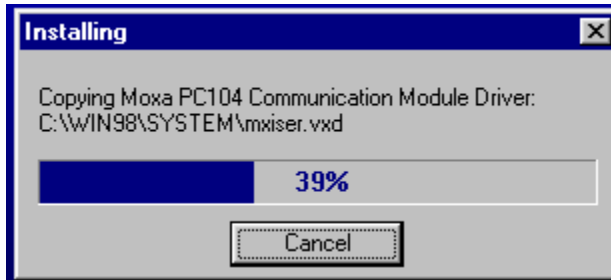

- After the files have been installed, a configuration panel will open. Click **Add** to continue.

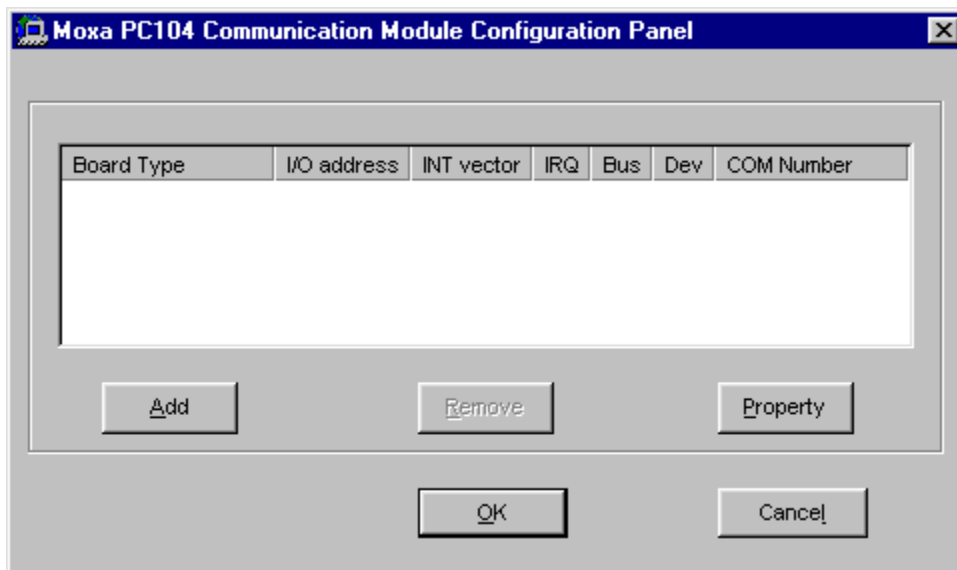

- Under **Board Type**, select your CA Series model. The window will show the COM port numbers that will be assigned to the CA Series serial ports, as well as other settings. Click **OK** to continue.

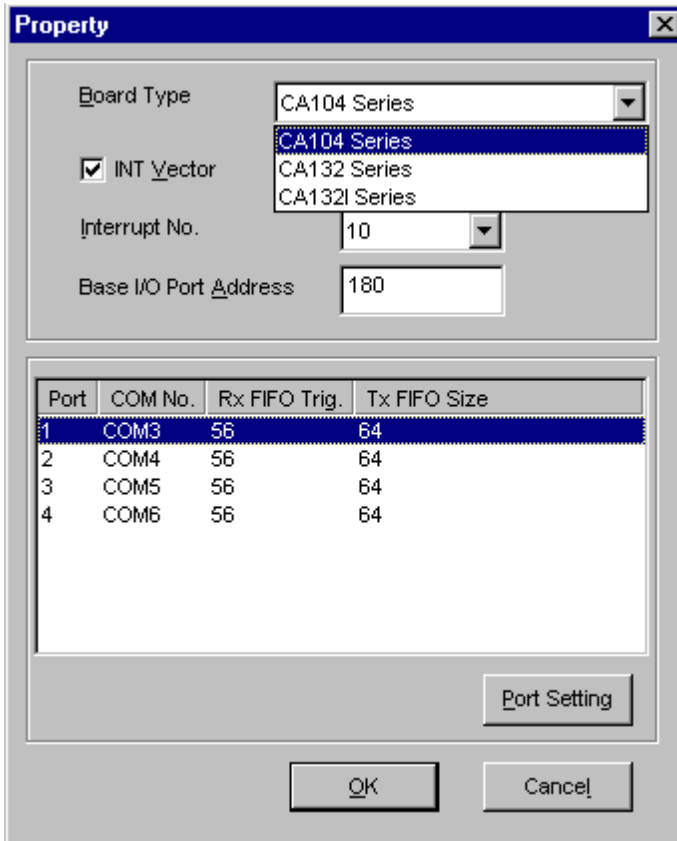

- The CA Series module will now appear in the configuration panel. Click **OK** to complete installation of the module.

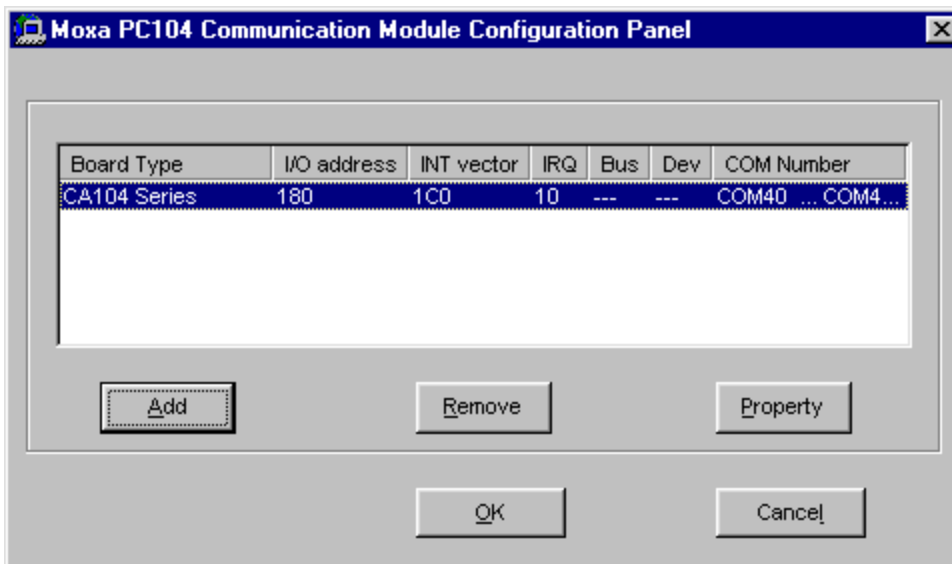

Open the configuration panel again through **Start → Programs → Moxa Utilities → MOXA PC104 Communication Module Configuration Panel**.



## Uninstalling the Module

1. Open the configuration panel through **Start>Programs>Moxa Utilities>Moxa PC104 Communication Module Configuration Panel**. Select your CA Series module and click Remove

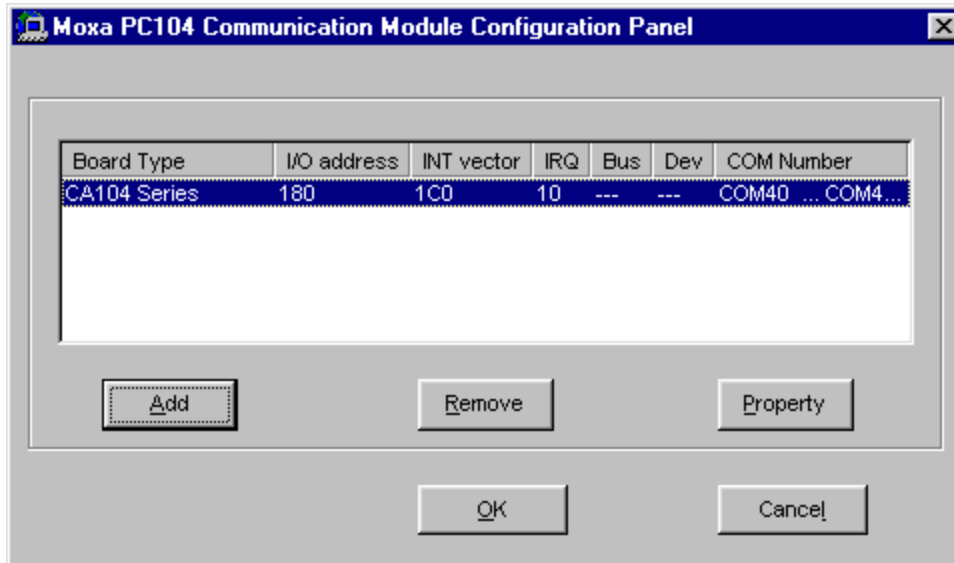

2. A confirmation dialog will appear. Click **Yes** to uninstall the device.

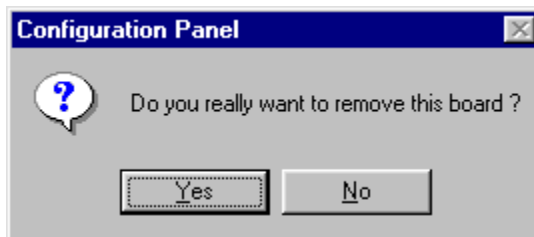

3. To remove the driver from the system, open **Add/Remove Programs** in the **Control Panel**.



- Under the **Install/Uninstall** tab, select **MOXA PC104 Communication Module Driver** and click **Add/Remove**.

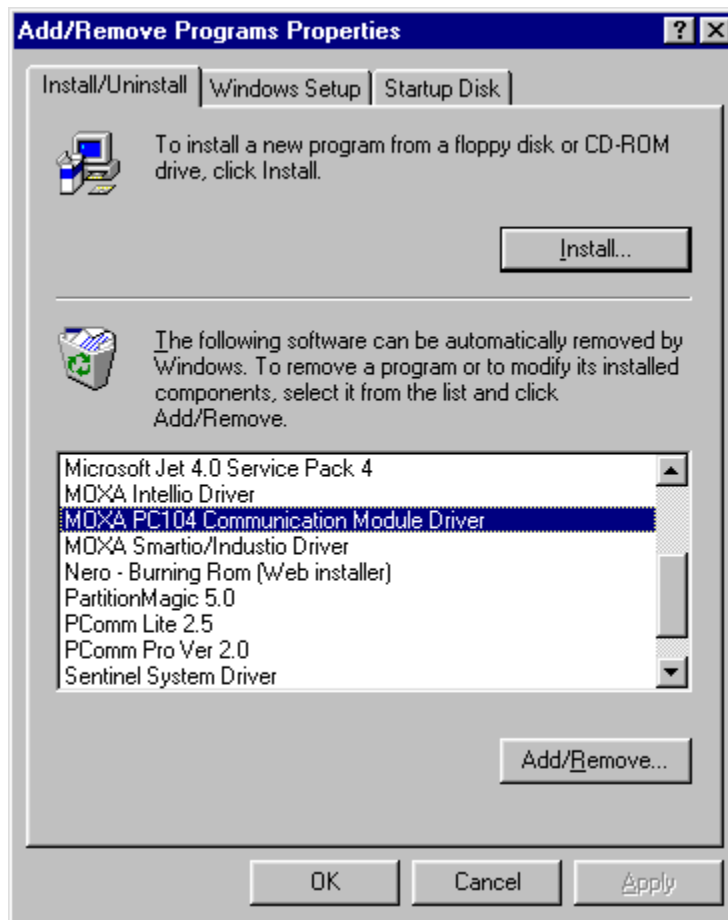

- A confirmation dialog will appear. Click **Yes** to remove the driver.

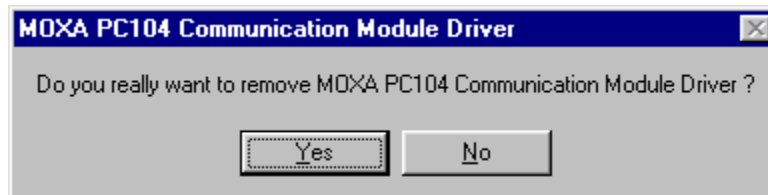

- After the driver has been removed, click **OK** to close the window.



## Windows CE 5.0

In this section, we explain how to install Moxa CA series boards under WinCE 5.0. These instructions are intended for users who are familiar with the Windows CE Platform Builder 5.0 ToolKit, and who would like to install one or more Moxa Tech products. Here, we only give the step-by-step installation instructions for the development environment. You will need to download the image file to the target host yourself.

The WinCE 5.0 driver for the Moxa CA Series PC/104 Multiport Serial Module supports the following products:

CA Series: CA-108, CA-114, CA-134I, CA-104, CA-132, and CA-132I.

In the the following steps, we are using CA-104 as an example.

### Installing the driver

The following procedure explains how to install the CA-104 multiport serial module driver under WinCE.

1. Obtain a copy of the Moxa Tech WinCE 5.0 driver package and extract it to your computer. Double-click the **Installation** icon to copy the Mxpcdrv folder to %WINCEROOT%\PLATFORM\ automatically, and import the supported Moxa Tech products into the **Folder**.
2. Start WinCE Platform Builder, and then select **File →New Platform**.

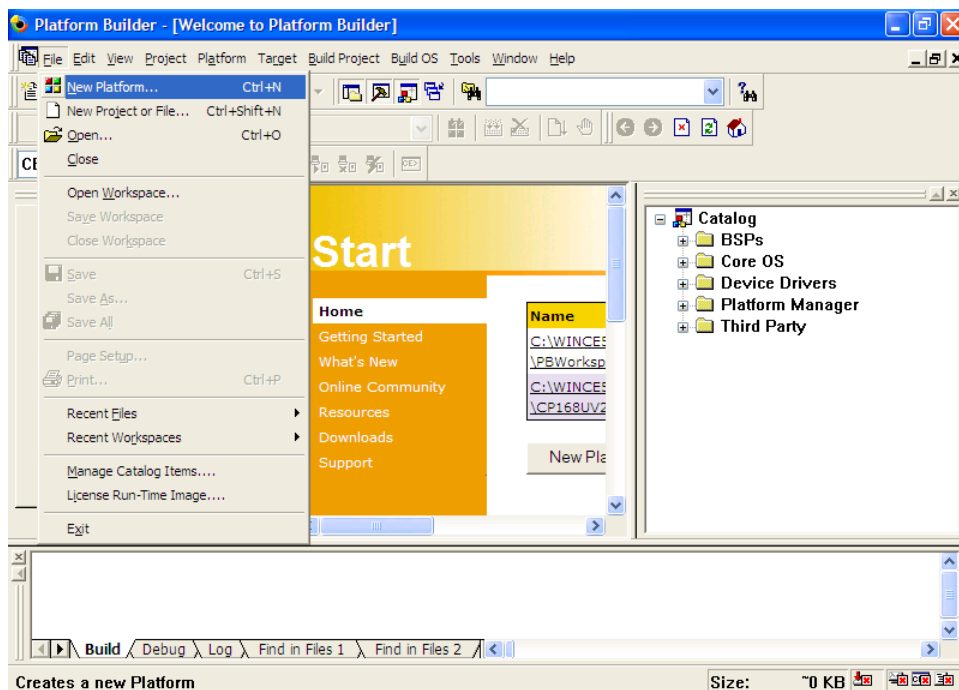

3. Enter a workspace name and then press **Next**.

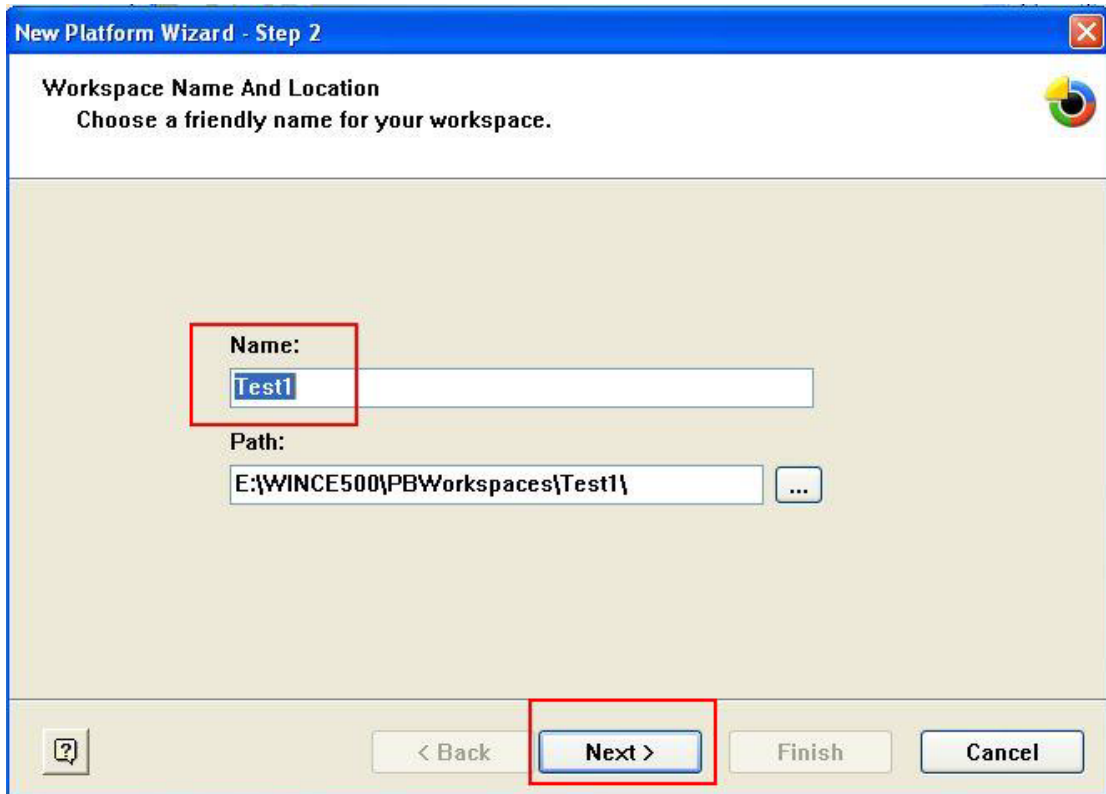

4. When you see Board Support Packages, Design Template, Applications & Media, Networking & Communications, OBEX Server, select what you need to build your own environment. The **Completing the New Platform Wizard** window will open to indicate that it has created a new platform. Click **Finish** to complete the setup.

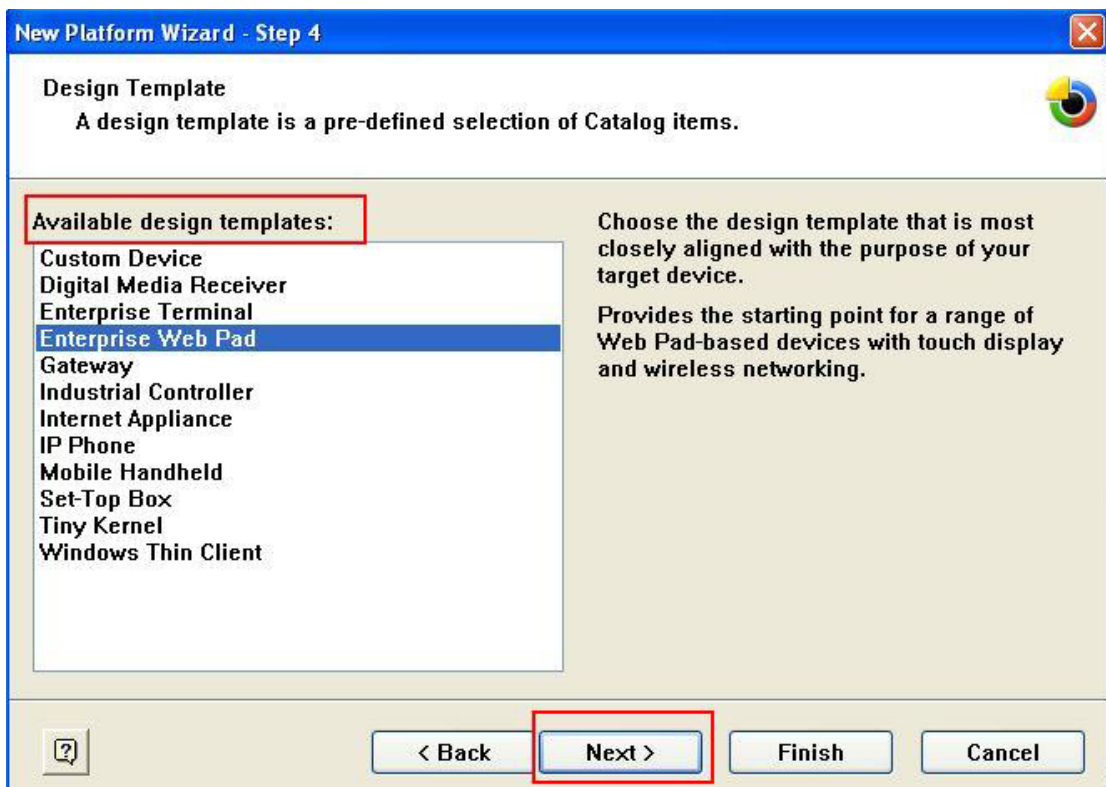

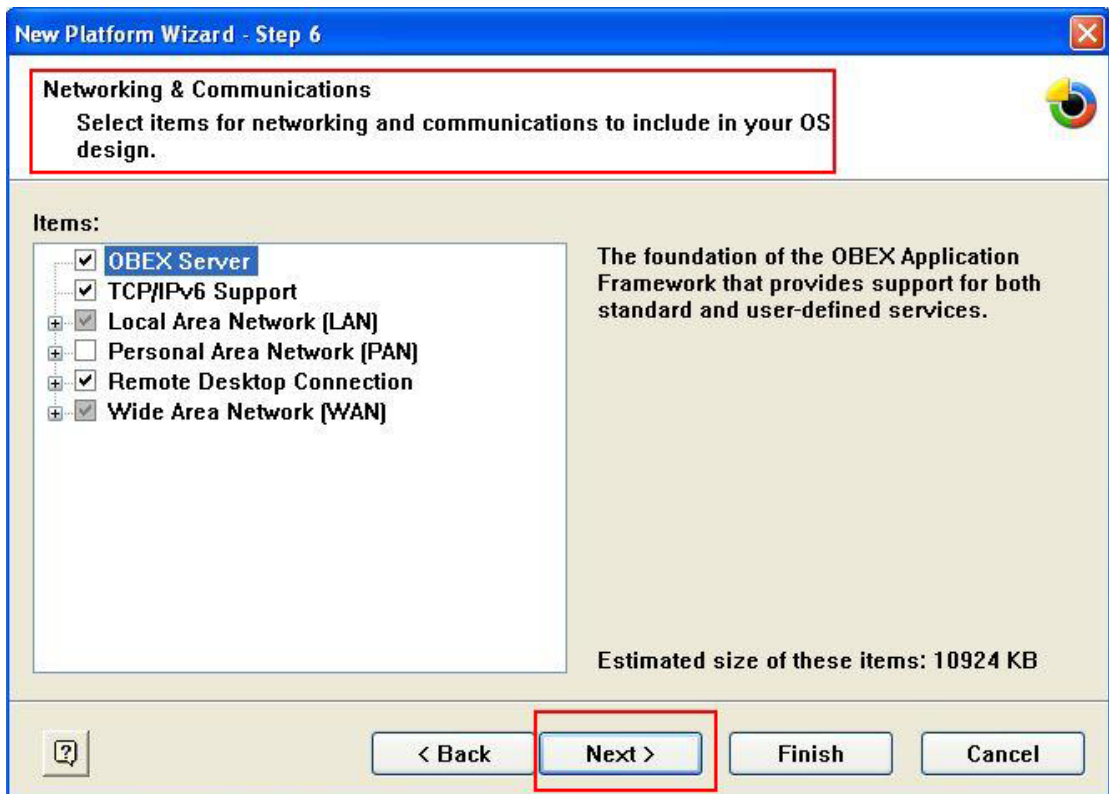
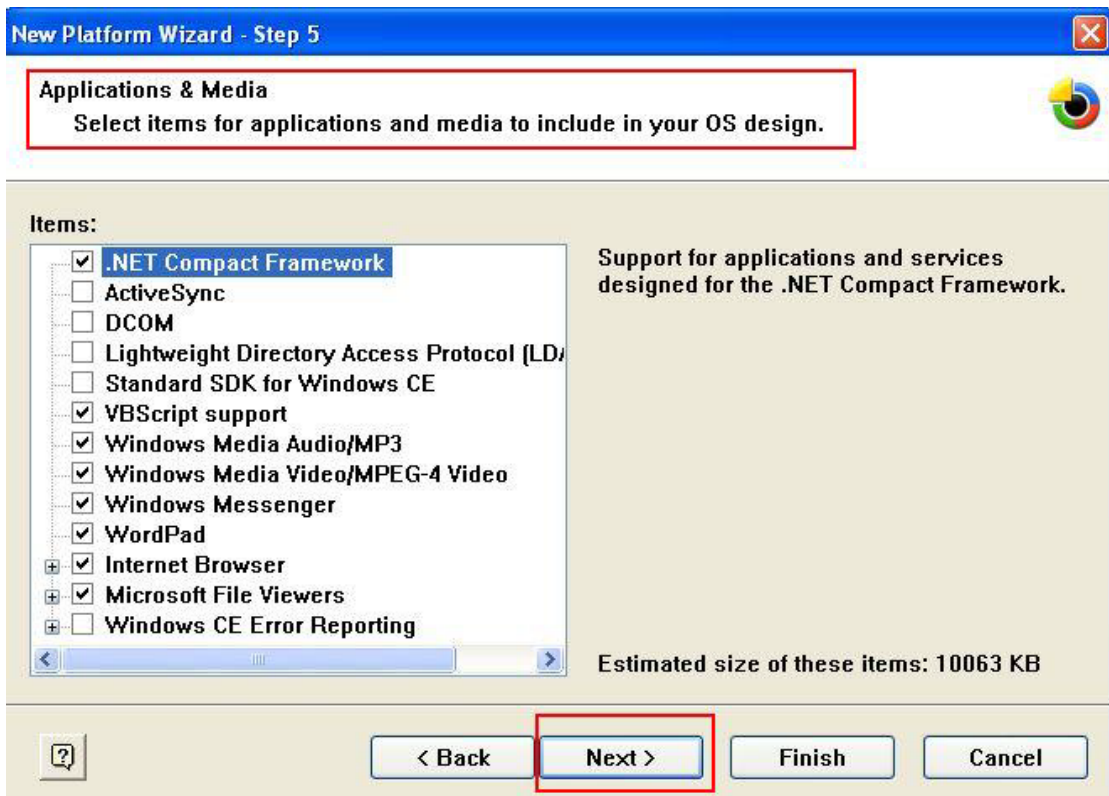



5. Select **File** → **Manage Catalog Items In View** → **Catalog**, and browse **\Third Party\Device Drivers\MOXA Smartio/Industio-PC/104**. Right-click on the driver Prefix COM or Prefix MXU you would like to include and choose **Add to OS Design**.

**NOTE** You can only select either Prefix COM or Prefix MXU, but not both.

Prefix COM supports up to 10 ports, from COM0 to COM9. Prefix MXU supports more than 10 ports, so it is better for you to select Prefix MXU if you are not sure how many ports the device has. Otherwise, you will only be allowed to use one multiport serial board on the target host.

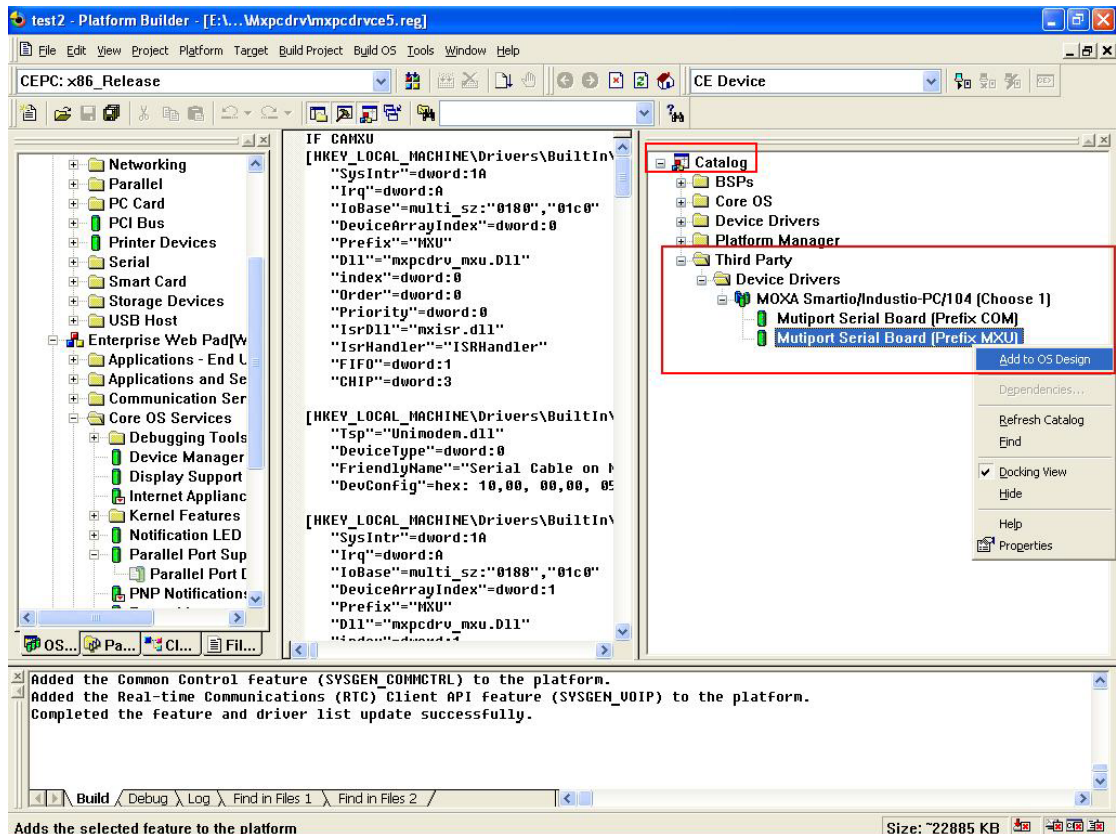

- After adding Moxa Tech drivers into your OS Design, a new project is automatically added to your workspace. The project name is mxpcdrvce5.reg. The project can be accessed from **View** → **File View**. The mxpcdrvce5.reg project contains a number of files used to configure the drivers included in your OS Design. For ISA boards, remember to set the IRQ and I/O address in mxpcdrvce5.reg. For example, if your IRQ is 10, IOBASE is 0180, Interrupt and Vector is 01c0, then you should configure "1A" for SysIntr, "0180" and "01c0" for IOBASE, "A" for IRQ, and "1" for FIFO. When applying the formula "IRQ+10", remember that IRQ is in base 10, and 10 is in Hex format. If we first convert the IRQ value to Hex format, then SysIntr will equal 1A. Otherwise, set FIFO to 1 to enable the FIFO.

**NOTE** To use the "Terminal Emulator" tool, modify mxpcdrvce5.reg and keyboard as shown below (this is just for "one" "COM" port). Take note of the number of ports, COM, and MXU, and then enter the correct information.

```
[HKEY_LOCAL_MACHINE\ExtModems\HayesCompat1]
"Port"="COM2:"
"DeviceType"=dword:1
"FriendlyName"="Hayes Compatible on COM2:"
```

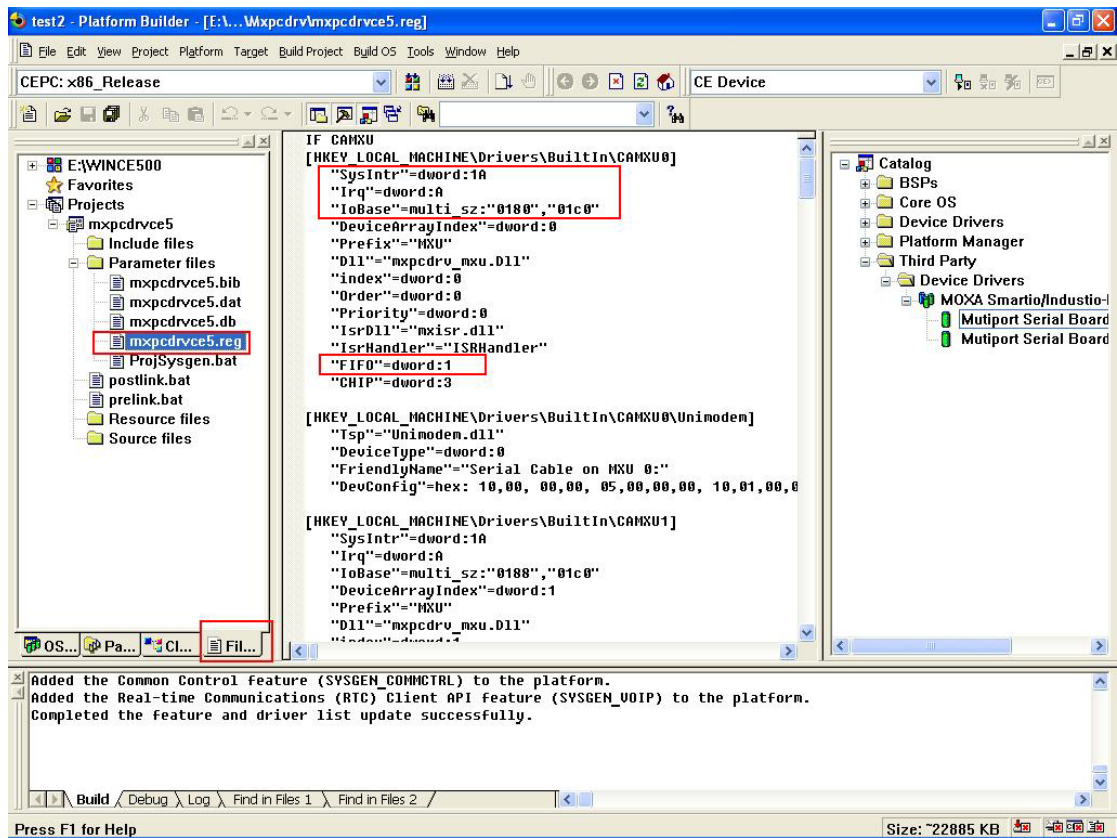

- Finally, open Build OS, select Build and Sysgen, and be sure to click **Copy Files to Release Directory After Build** and **Make Run-Time Image After Build**.

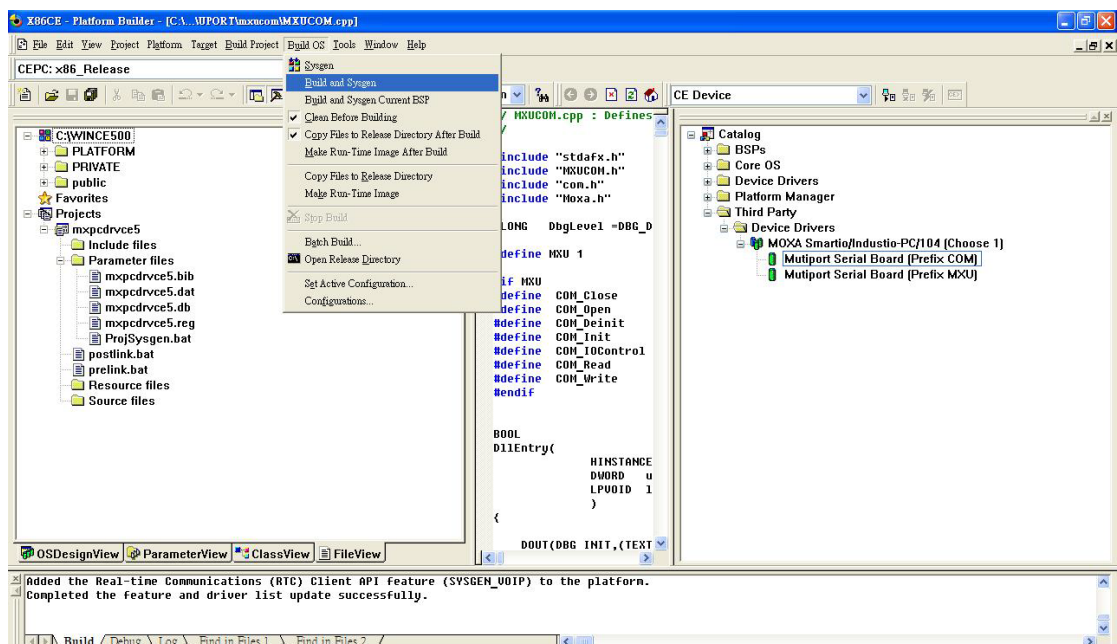

- Finally, copy your image file to the target host.

**NOTE** If you created a Windows CE Platform Builder in the development environment, skip steps 2, 3, and 4.



## Older OS for CB Series

### DOS

Moxa DOS API-232 is a software package that can help you develop or debug serial communications programs. This section will explain how to install the package, set up the driver, and load or unload the driver. For additional information about the API-232 library and utilities, please refer to Chapter 4.

The DOS drivers support all models in the CB Series.

In the following instructions, the CB-104 is used as an example.

### Installing the Driver

Run the installation program, **DOSINST.EXE**, in the DOS folder. Specify the target directory for the API-232 files (e.g., **C:\MOXA**). Press **F2** to start the installation.



After the installation has been completed, you will be prompted to set up the board and driver initial values. We strongly recommend that you do so.



## Driver Setup

The following instructions are not intended to illustrate every function of the setup program. For more detailed information, please refer to the help files by pressing F1 in the setup program.

1. Run the setup program **BIN\SETUP.EXE**.
2. Select your CB Series model and press **Enter**.
3. A window will open, displaying all configuration information for all installed modules. Press **PgDn** to view advanced port setup options and to make configuration changes. Your module's configuration will be displayed along with other settings such as port number, buffer size, etc.
4. Verify the settings and make any necessary changes.

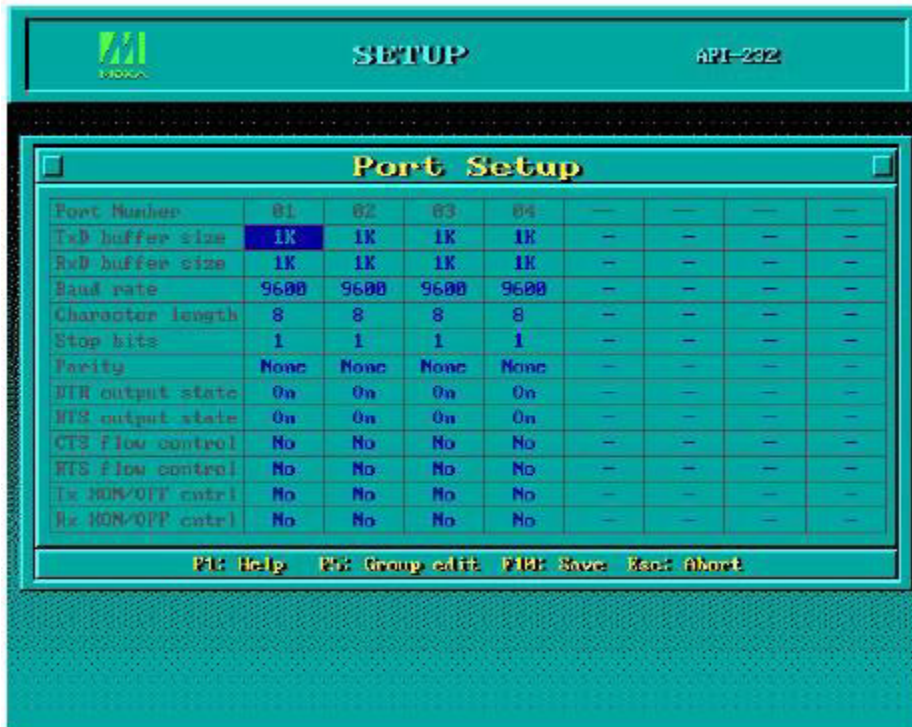

**Port number:** This is the port ID of each port. Application software will refer to a port by its port number (ID). Port numbers must be unique; duplicate port numbers are not allowed. The port ID can range from 0 to 127 as long as it does not overlap with another port. Generally, you should consider the convenience of programming when specifying the port number.

**TxD buffer size:** This is the transmission (output) buffer allocated in the system for each port.

**RxD buffer size:** This is the receiving (input) buffer allocated in the system for each port.

**F5: Group Edit:** This allows you to configure several ports simultaneously as a group.

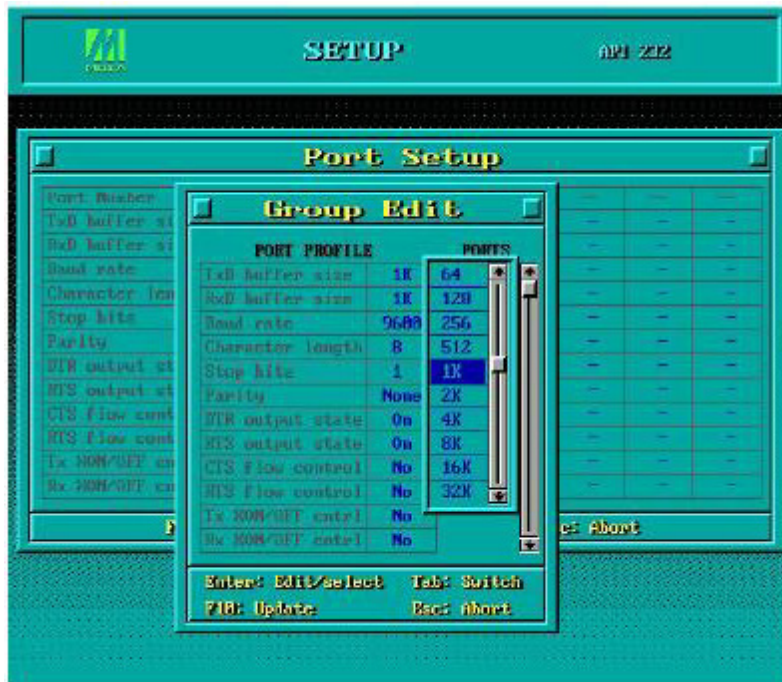

5. Press **F10** to save the latest configuration and exit the setup program.

## Loading the Driver

After setting up the driver, you must load the driver in order to gain access to the serial ports on the module. Run **BIN\DPC-DRV.EXE** at the DOS prompt. The driver will detect your CB Series module automatically. You should see messages indicating successful detection of your module, such as the following:

```
Smartio/Industio Family DOS driver Version 1.8
Setup driver ...
CB-114 series (Bus=x, Dev=y): OK!
Device driver setup O.K.
```

At this point, you can execute applications that support API-232 functions, or start developing applications using the API-232 library.

## Unloading the Driver

To unload or release the CB Series driver from memory, enter **DPC-DRV/Q** at the DOS prompt.

## Windows NT

### Installing the Driver

You will need to plug the board in an available PCI or PCI-X slot first, before installing the driver.

Note that these instructions use the CB-114 as an example. The procedure for installing all models is the same.

1. Log into Windows NT as Administrator.
2. Locate the appropriate folder for your board's drivers on the Document & Software CD. The NT drivers will be located under the product folder in the **\Software\WinNT** directory (e.g., under **\CB-114 Series\Software**). Copy this folder to the PC's hard disk and remember its location.
3. In the **Control Panel**, open **Network** applet. On the **Adapters** tab, click **Add**. When prompted to select a product, click **Have Disk....**

You will be prompted to enter the path to the driver. Enter the location of the drivers that you copied from the Document & Software CD (**C:\Windows.nt** in this example) and then click **OK**.

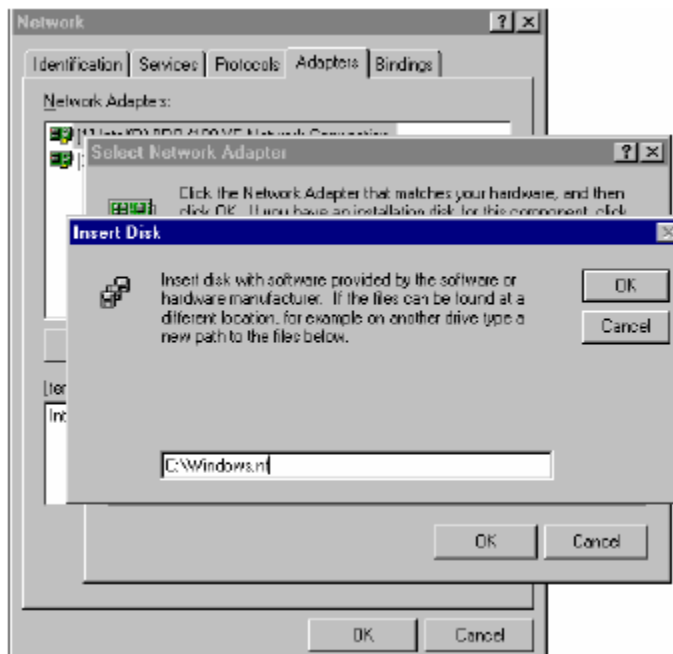

4. When prompted, select your board model (**Smartio/Industio Family multiport board** in this example) and click **OK**.



- After the files have been installed, a configuration panel will open. This is where boards are installed, configured, and removed. If another board has already been installed on the system, it will already be listed. Windows NT does not automatically detect Moxa UPCI boards, so you will need to click **Add** for a newly installed board.

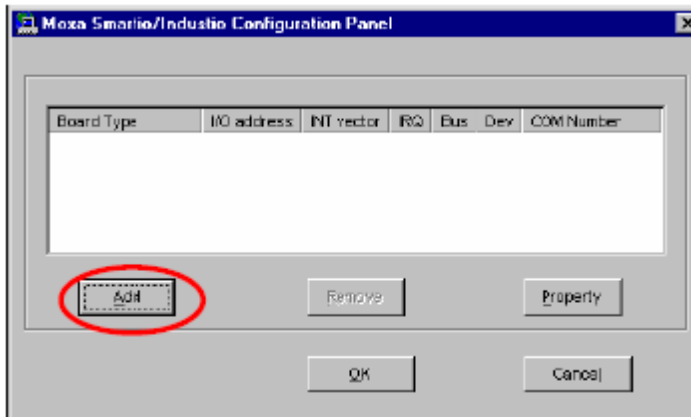

- Under **Board Type**, select the UPCI board that is being installed. The window will show the COM settings for the serial ports on the board. You can modify the COM settings for any port at this time by selecting a port and clicking **Port Setting**. If you are satisfied with the COM settings, click **OK** to return to the configuration panel.

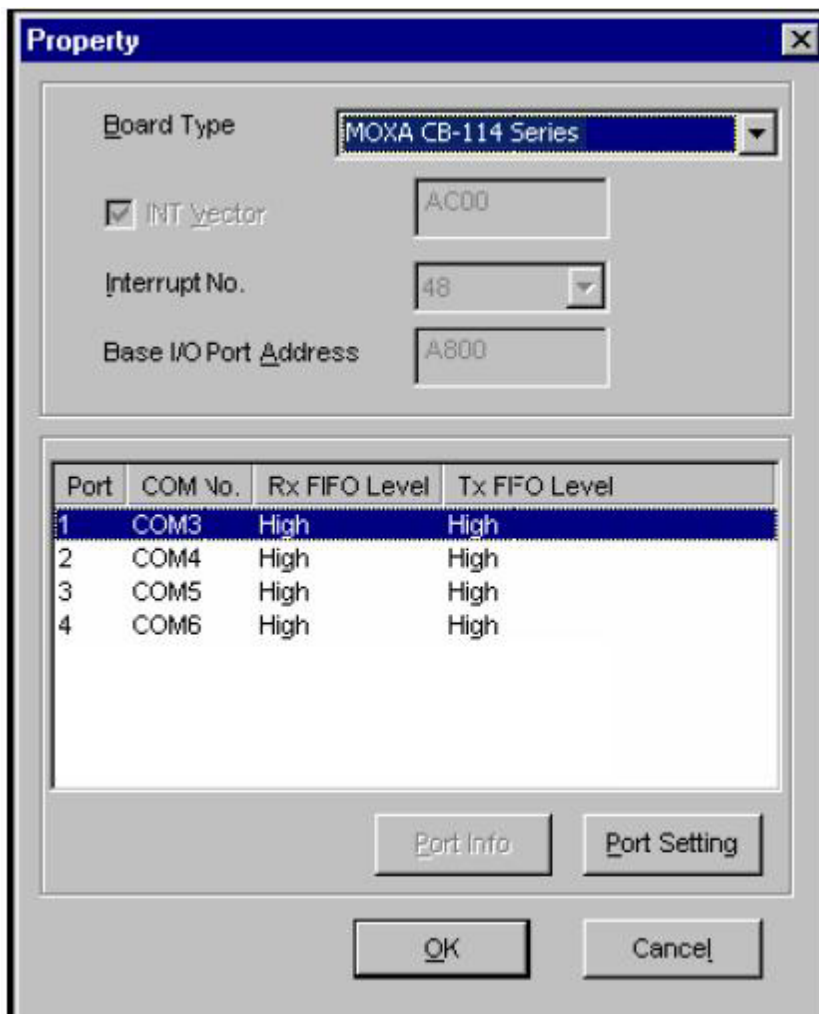

- The board will now appear in the configuration panel (**CB-114 Series in this example**). Click **OK** to return to the Network applet. After that, click **OK** again to exit the Network applet

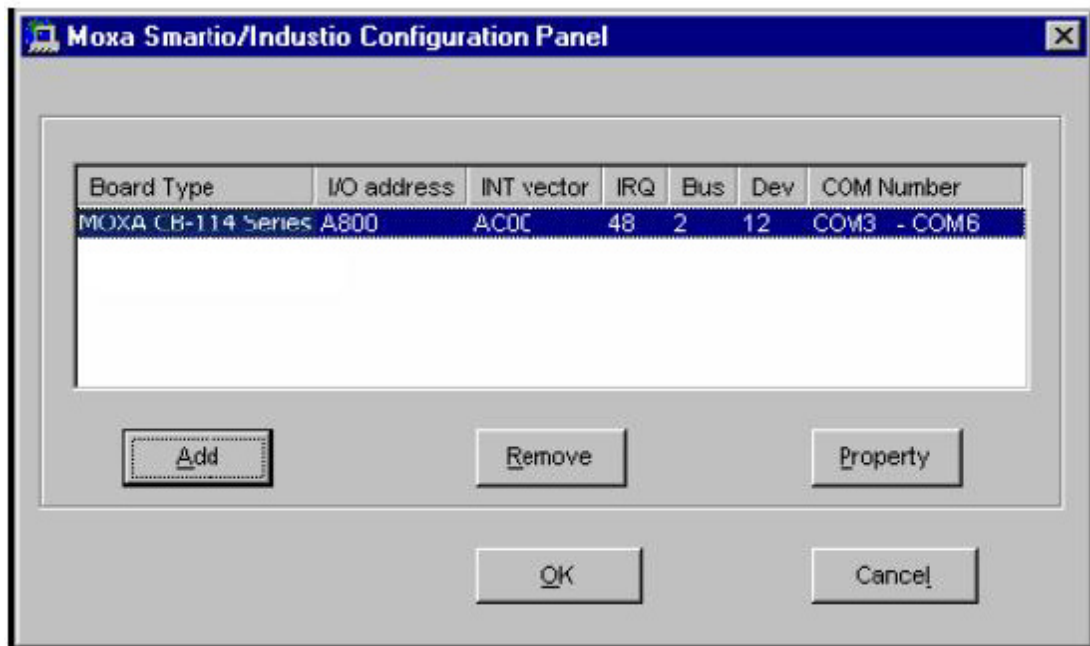

- Restart the PC. After you have logged back into Windows NT, you may check the event log issued by the Moxa driver to see if the board's ports have been initialized successfully. In the **Administrative** group, open **Event Viewer** and select **Log and System**. For each newly installed or configured Moxa UPCI board, check for a message stating that the board has been enabled (e.g., "MoxaCB-114 board, with first serial port COM3, has been enabled").

## Configuring the Ports

- In Windows **Control Panel**, open the **Network** applet. In the **Adapters** tab, UPCI boards will appear as a type of Moxa adapter (**MOXA Smartio/Industio Family Adapter** in this example). Select the Moxa adapter and click **Properties...**

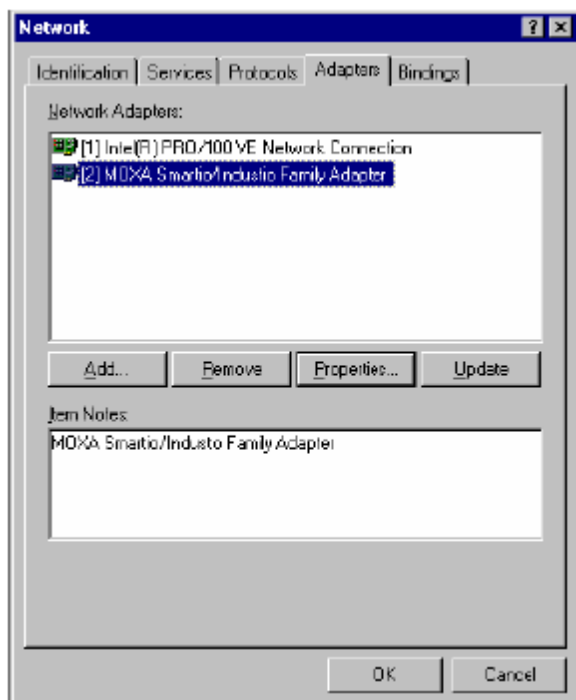

- The configuration panel will open with a list of installed boards. Select your board and click **Property**. Up to four Moxa UPCI boards can be installed at a time.

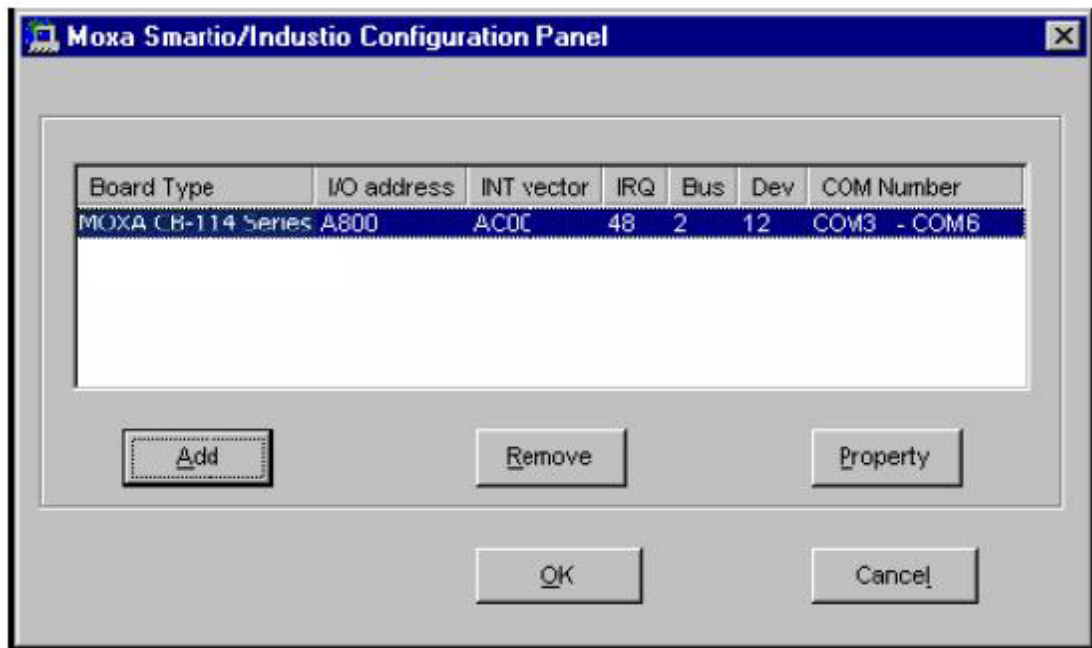

- Select a port to configure and click **Port Setting**.

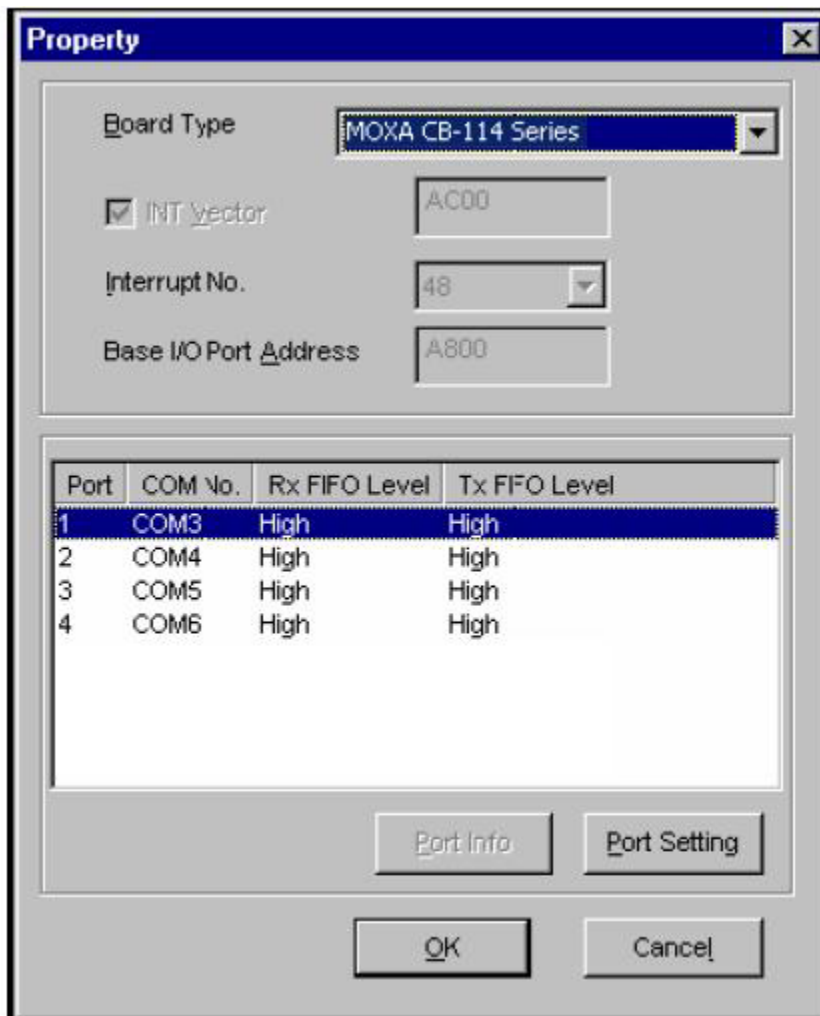

Under **Port Number**, select a COM number to assign to the serial port. Select **Auto Enumerating COM Number** to map subsequent ports in numerical order. For example, if COM 3 is assigned to Port 1, then COM 4 will be automatically assigned to Port 2.

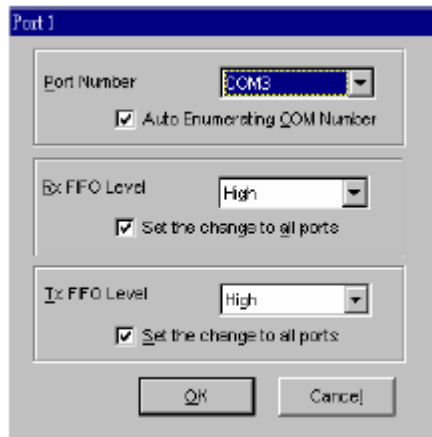

4. Select an **Rx FIFO Trigger** and **Tx FIFO Size**. The default Rx FIFO Trigger is 120 bytes (high level). The default Tx FIFO Size is 128 bytes (high level). Select **Set the change to all ports** to use this setting for all serial ports on the board.

	TxFIFO	RxFIFO
High	128	120
Middle	64	60
Low	1	1

5. Click **OK** to approve the settings for the selected port. Continue in the same way to configure the other ports. When you have finished setting up the ports, click **OK** to close the **Properties** window and apply the new port settings. Click **OK** again to exit the Network applet.

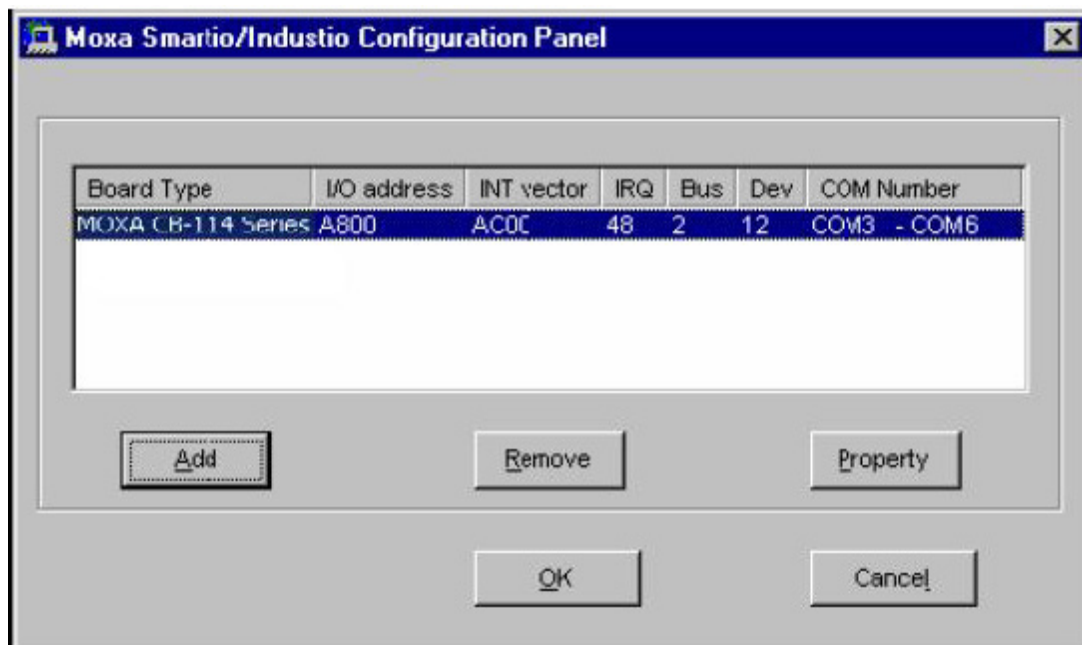

### Removing the Board

To remove a board, shut of your PC and physically remove the board from the PCI slot. The next time you start up the PC, Windows NT will automatically remove the configuration. You do not need to go through the Windows control panel.



## Updating the Driver

1. In Windows **Control Panel**, open the **Network** applet. Under the **Adapters** tab, UPCI boards will appear as a type of Moxa adapter (**MOXA Smartio/Industio Family Adapter** in this example). Select the Moxa adapter and click **Remove**.

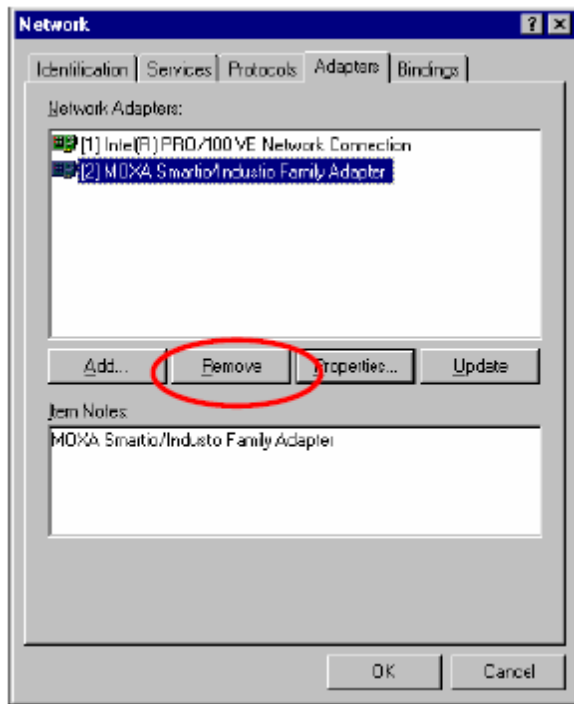

2. Restart the system.
3. Go through the process of installing the drivers, using the new drivers.

## Removing the Driver

1. In the Windows **Control Panel**, open the **Network** applet. Under the **Adapters** tab, UPCI boards will appear as a type of Moxa adapter (**MOXA Smartio/Industio Family Adapter** in this example). Select the Moxa adapter and click **Remove**.

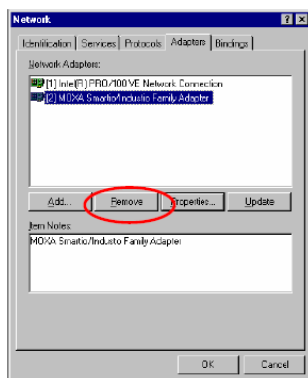

2. Click **OK** to exit the Network applet and restart the system.

## Windows 95/98/ME

### Installing the Driver

#### Windows 95

1. After the board is physically installed and the PC boots up, Windows will automatically detect the new board and the Found New Hardware Wizard window will open. Click **Next** to continue.



2. Select **Other Locations...**

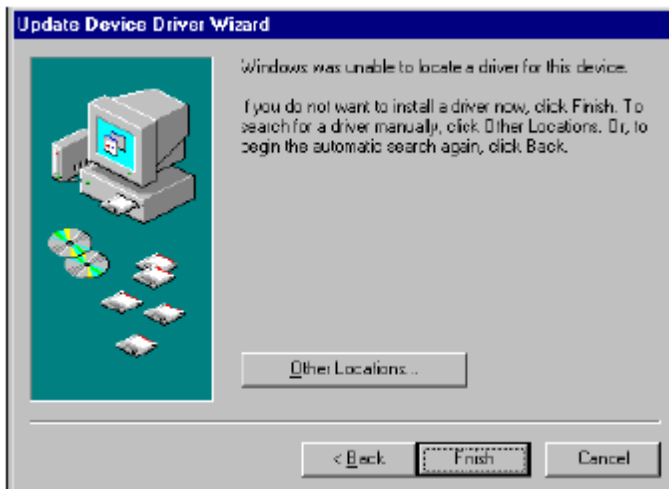

3. Click **Browse** and select the appropriate directory on the Document & Software CD for the driver. Drivers for all operating systems are located under the product folder in the **\Software** directory. Select the **\Win9x** folder and click **OK** to continue.

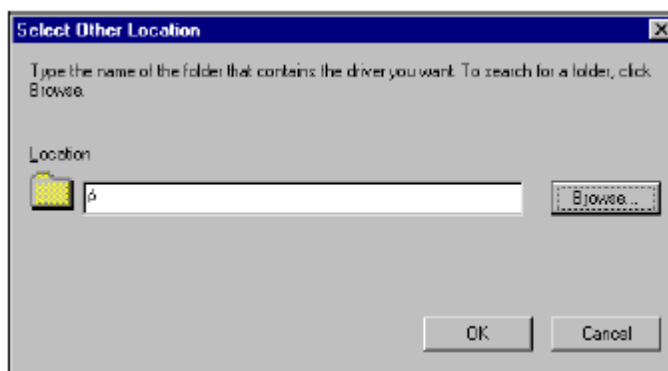

4. After Windows finds the drivers, click **Finish**.



You can configure and use the new COM ports right away without restarting Windows.

### Windows 98 and ME

1. After the board is physically installed and the PC boots up, Windows will automatically detect the new board and the **Found New Hardware Wizard** window will open. Click **Next** to continue.

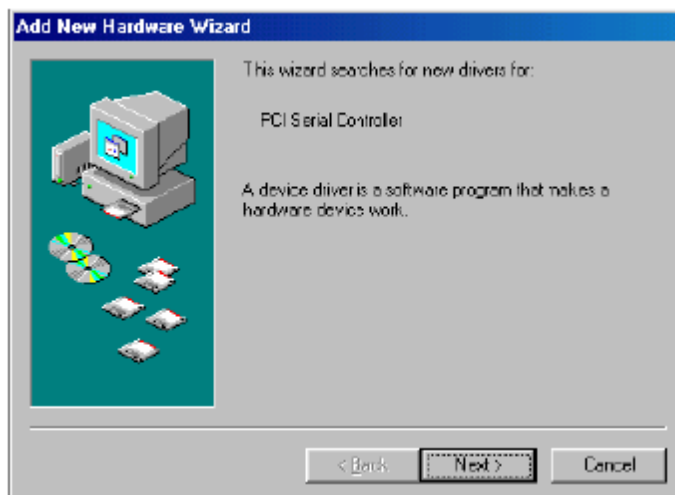

2. Select **Display a list...** and click **Next**.



3. Select **Other Devices** and click **Next**.

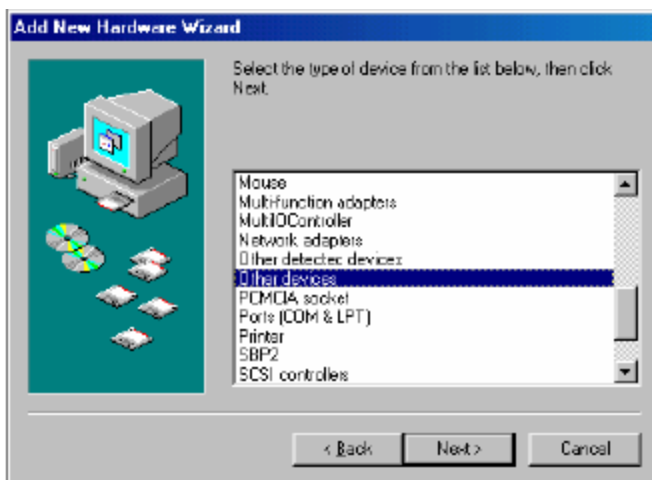

4. Select **Have Disk...**

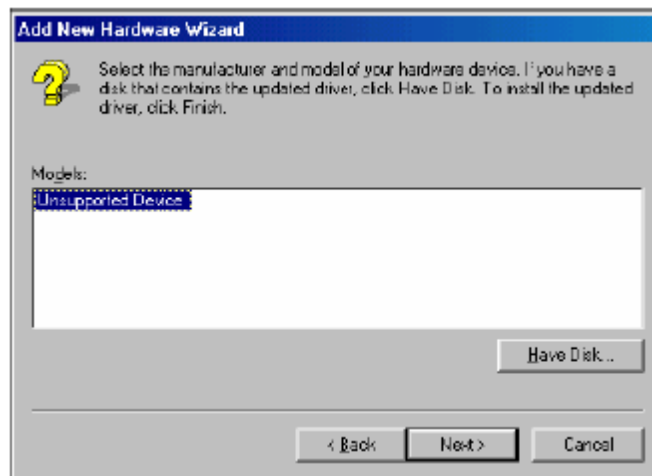

- Click **Browse** and select the appropriate directory on the Document & Software CD for the driver. Drivers for all operating systems are located under the product folder in the **\Software** directory. Select the **\Win9x** folder and click **OK** to continue.

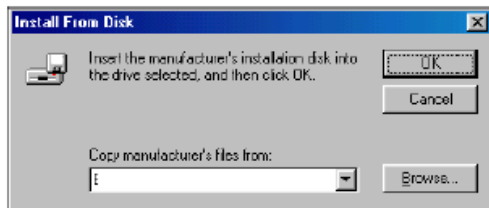

- After Windows has installed the drivers, click **Finish**.



## Configuring the Ports

Configure the COM ports after the board and drivers have been installed.

- In the Windows **Control Panel**, open the **System** applet.

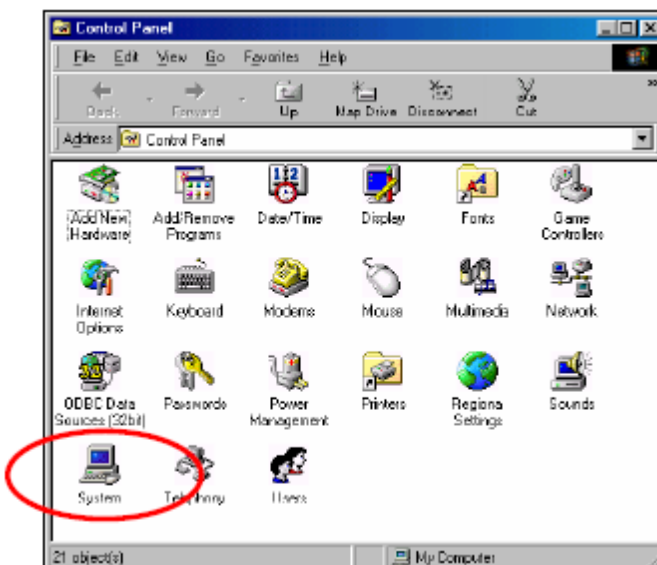

- In the **Device Manager** tab, expand the **Moxa Smartio/Industio multiport board** category by clicking the "+" sign next to it. Select the desired board and click **Properties**.

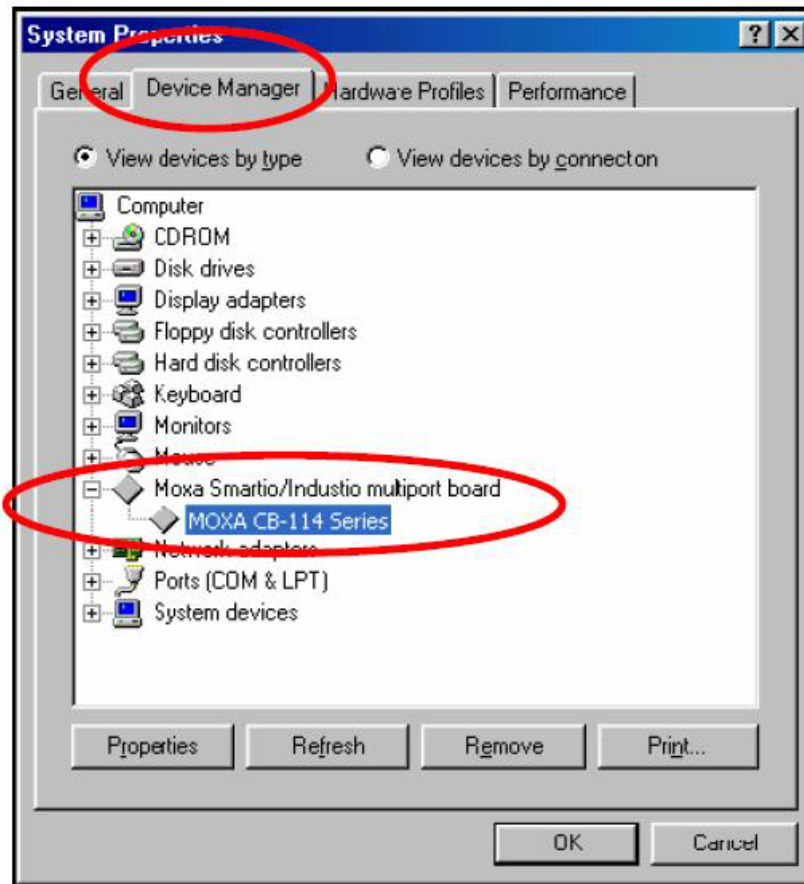

- Under the **Ports Configuration** tab, select a port to configure and click **Port Setting**.

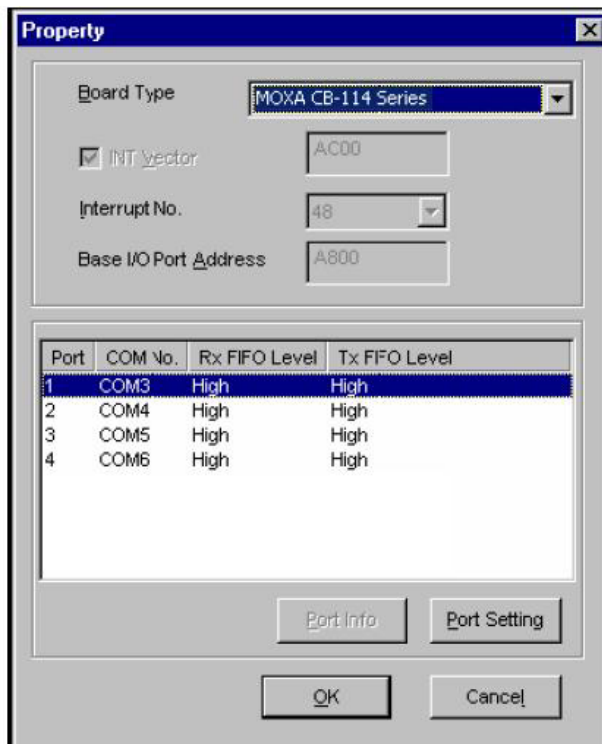

Under **Port Number**, select a COM number to assign to the serial port. Select **Auto Enumerating COM Number** to map subsequent ports in numerical order. For example, if COM 3 is assigned to Port 1, then COM 4 will be automatically assigned to Port 2.

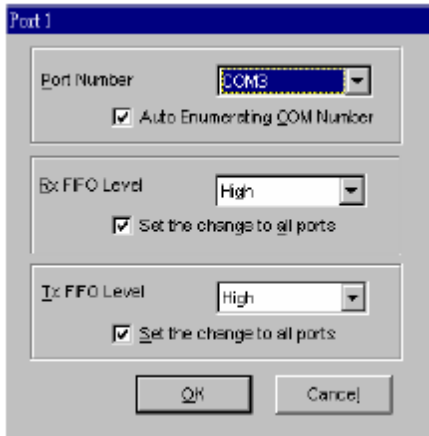

4. Select an **Rx FIFO Trigger** and **Tx FIFO Size**. The default Rx FIFO Trigger is 120 bytes (high level). The default Tx FIFO Size is 128 bytes (high level). Select **Set the change to all ports** to use this setting for all serial ports on the board.

	TxFIFO	RxFIFO
High	128	120
Middle	64	60
Low	1	1

5. Click **OK** to approve the settings for the selected port. Continue in the same way to configure the other ports. When you have finished setting up the ports, click **OK** to close the **Properties** window and apply the new port settings. Click **OK** again to close the **Device Manager** and restart the system.

## Updating the Driver

You may configure the COM ports after the board and drivers have been installed.

1. In the Windows **Control Panel**, open the **System** applet.

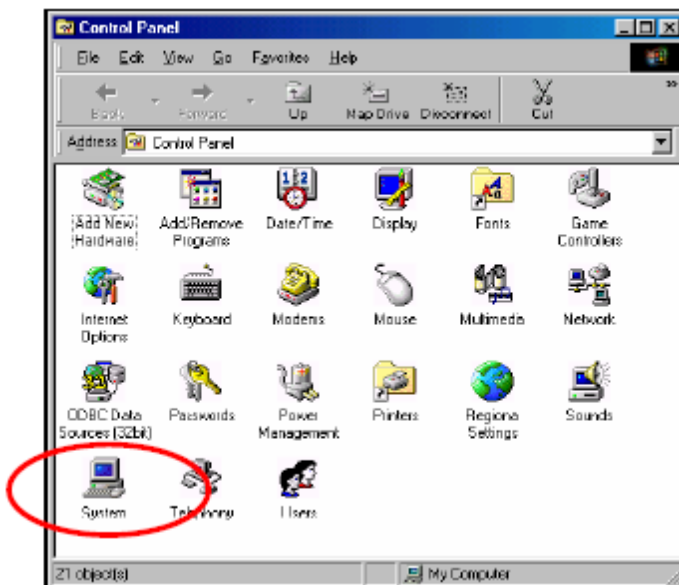

- Under the **Device Manager** tab, expand the **Moxa Smartio/Industio multiport board** category by clicking the "+" sign next to it. Select the desired board and click **Properties**.

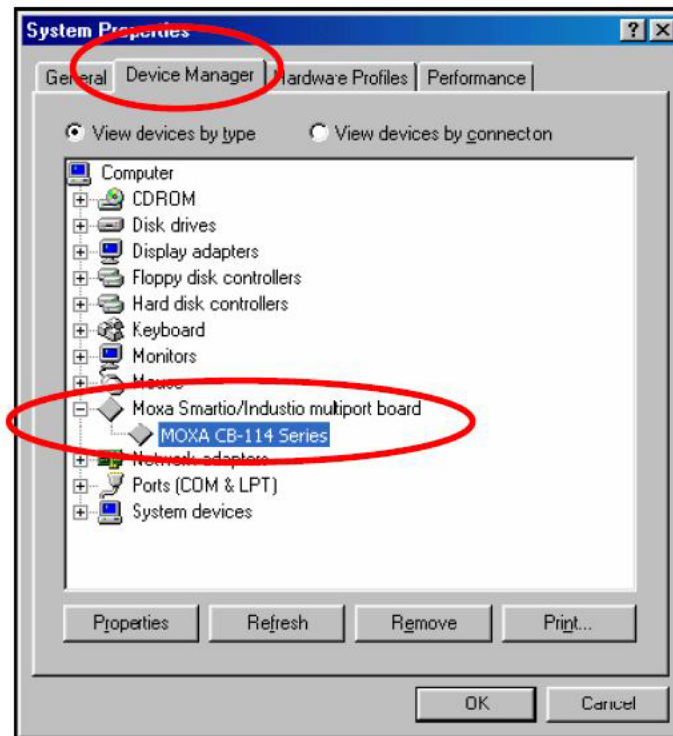

- In the **Driver** tab, click **Update Driver....**

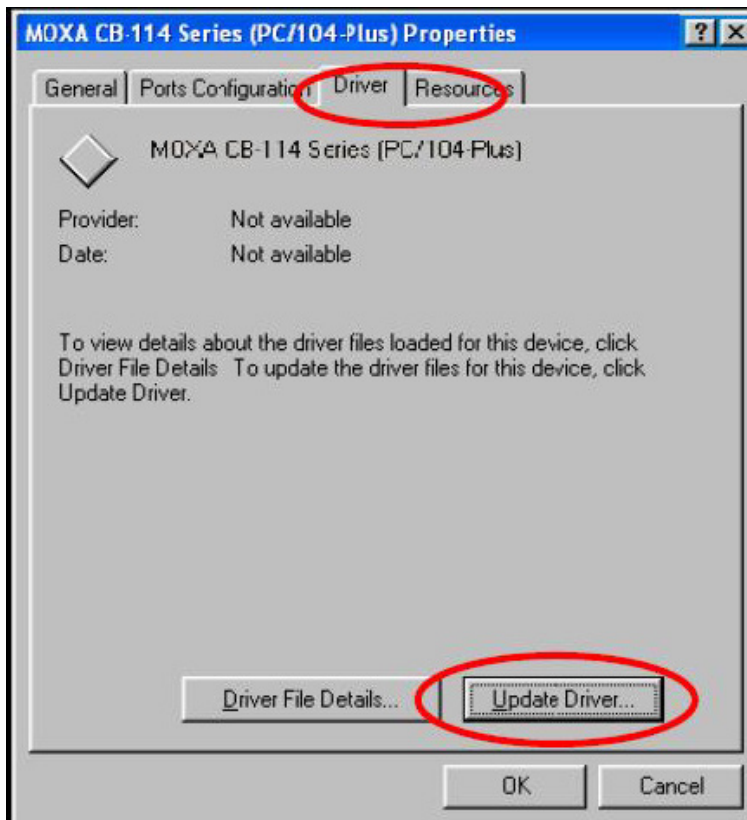



4. Select the appropriate model (CP-168U in this example) and click **Have Disk...**

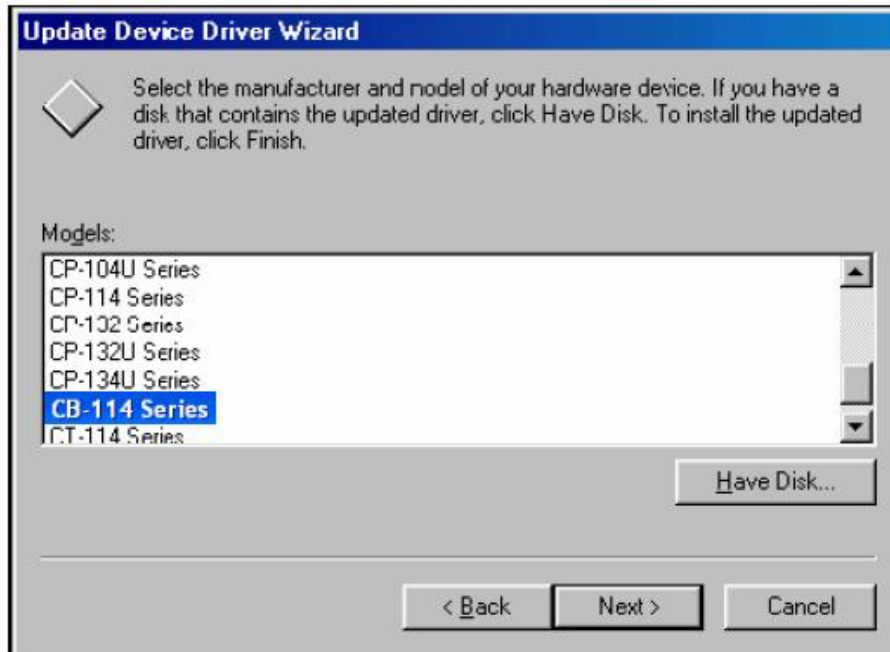

5. When prompted, select the appropriate directory on the Document & Software CD for the driver. Drivers for all operating systems are located under the product folder in the **\Software** directory. Select the **\Win9x** folder and click **OK** to continue.
6. You will be prompted to restart the system. The new drivers will be in effect the next time you restart.

## Removing the Driver

1. In the Windows Control Panel, open the **Add/Remove Programs** applet. On the Install/Uninstall tab, select **MOXA Smartio/Industio Driver** and click **Add/Remove**.

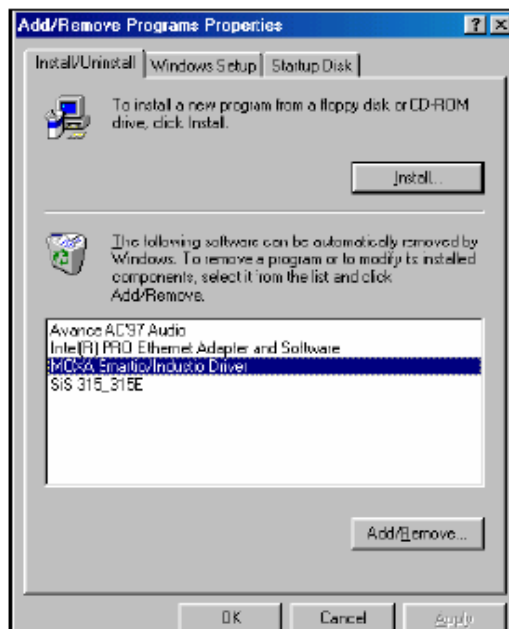

- When prompted, click **Yes** to confirm that you want to remove the driver.

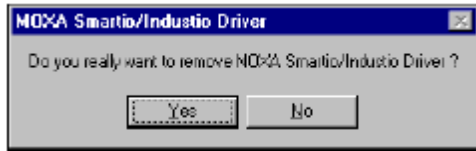

- After the driver has been removed, click **OK** to return to the **Add/Remove Programs** applet.



## Windows CE 5.0

In this section, we explain how to install Moxa CB series boards under WinCE 5.0. These instructions are intended for users who are familiar with the Windows CE Platform Builder 5.0 Toolkit, and would like to install one or more Moxa Tech products. Here, we only give the step-by-step installation instructions for the development environment. You will need to download the image file to the target host yourself.

The WinCE 5.0 driver for the Moxa CB Series PC/104-*Plus* Multiport Serial Module supports the following products:

CB Series: CB-108, CB-114, CB-134I

The CB-114 board is used to illustrate the installation procedure.

### Installing the driver

The following procedure explains how to install the CB-114 multiport serial module driver under WinCE.

- Obtain a copy of Moxa Tech WinCE 5.0 driver package and extract it to your computer. Double-click the Install package to copy the **Mxser** folder to %WINCEROOT%\PLATFORM\ automatically, and import the supported MOXA Tech products into the **Folder**.

2. Start WinCE Platform Builder, select **File**, and open **New Platform**.

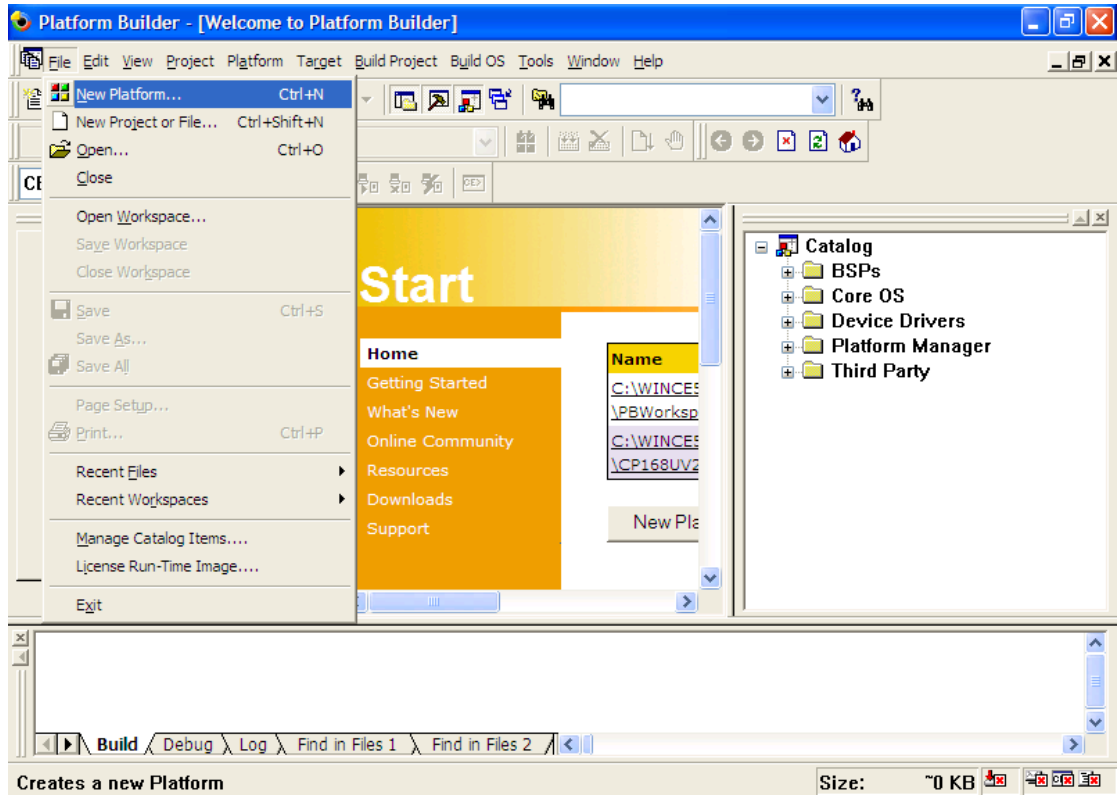

3. Enter a name for Workspace and press **Next**.

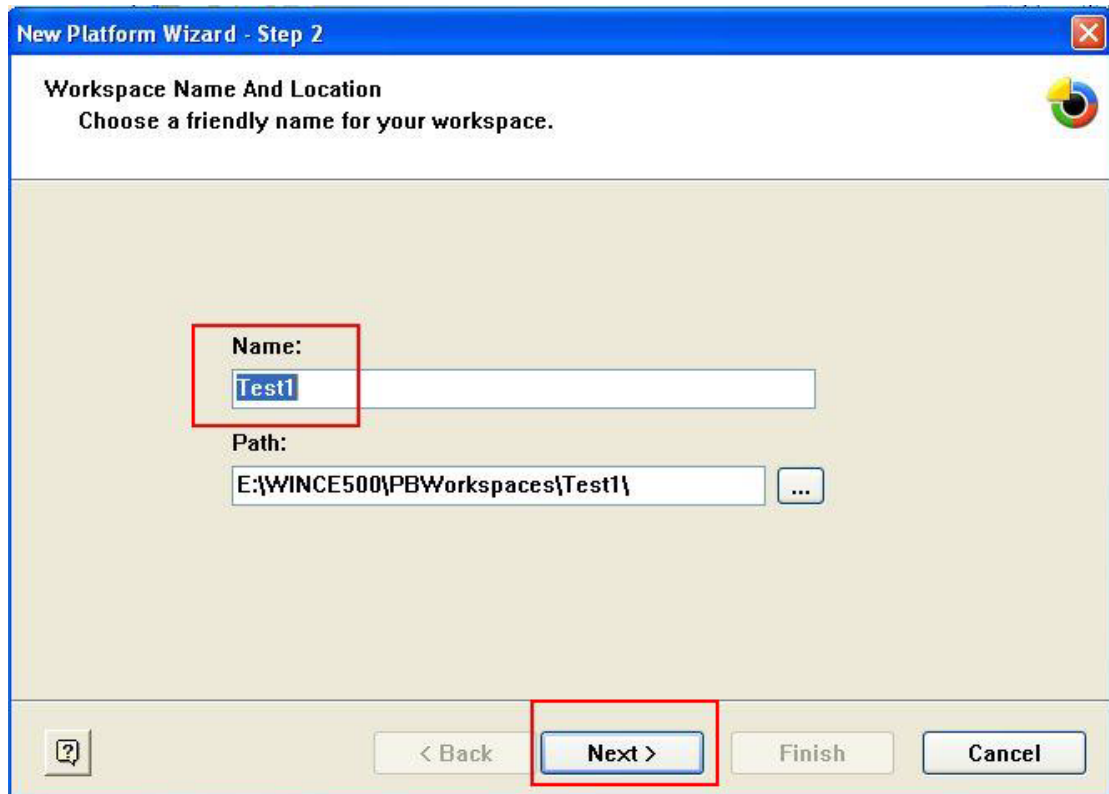

- When you see **Board Support Packages, Design Template, Applications & Media, Networking & Communications, OBEX Server**, select what you need to build your own environment. The **Completing the New Platform Wizard** window will open to indicate that it has finished creating a new platform. Click **Finish** to complete the setup.

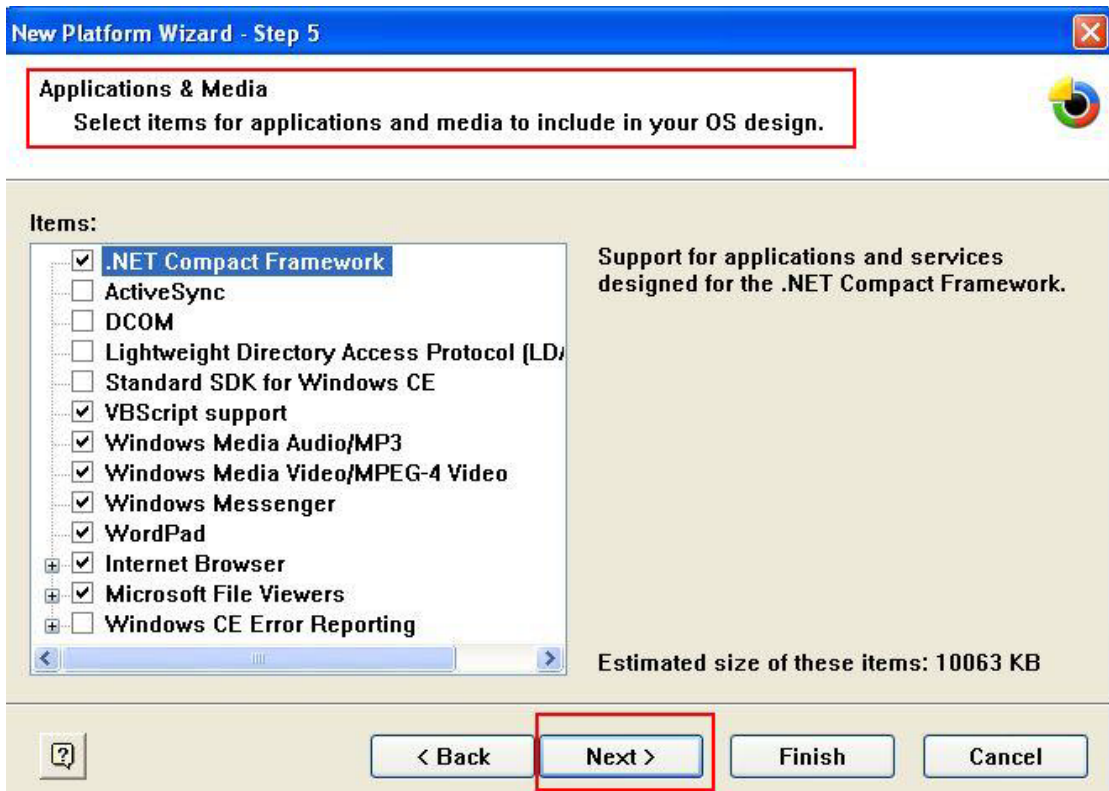
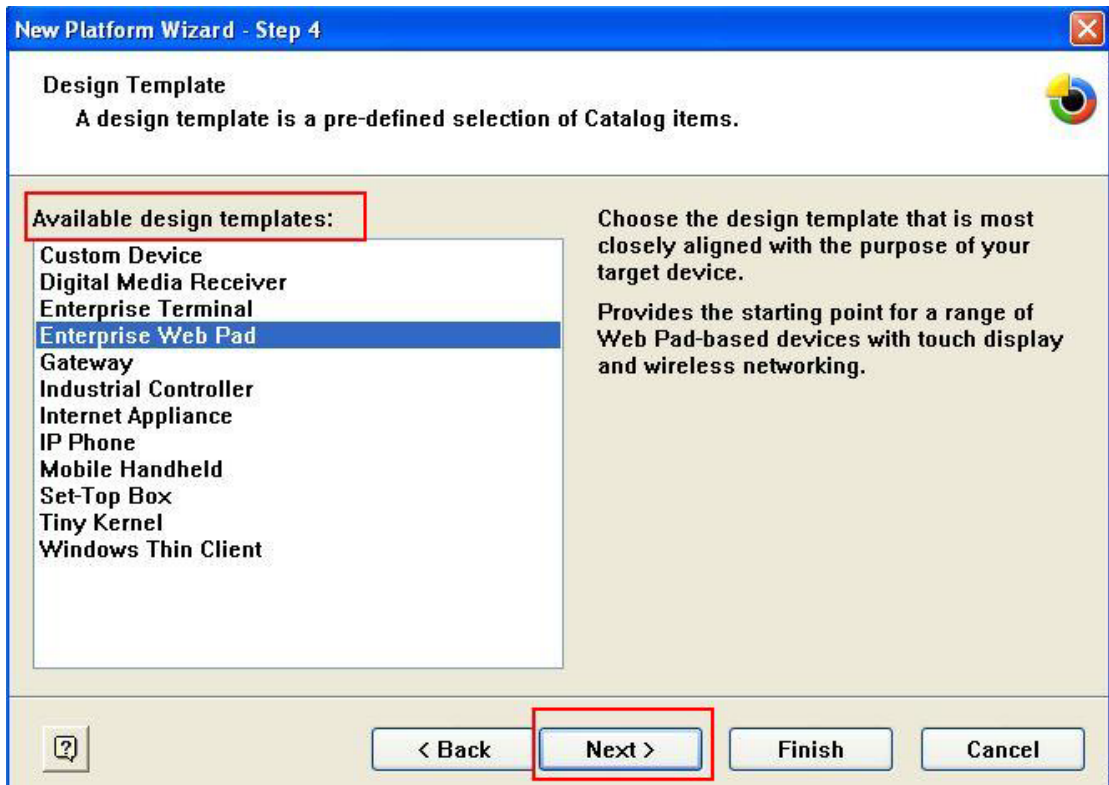

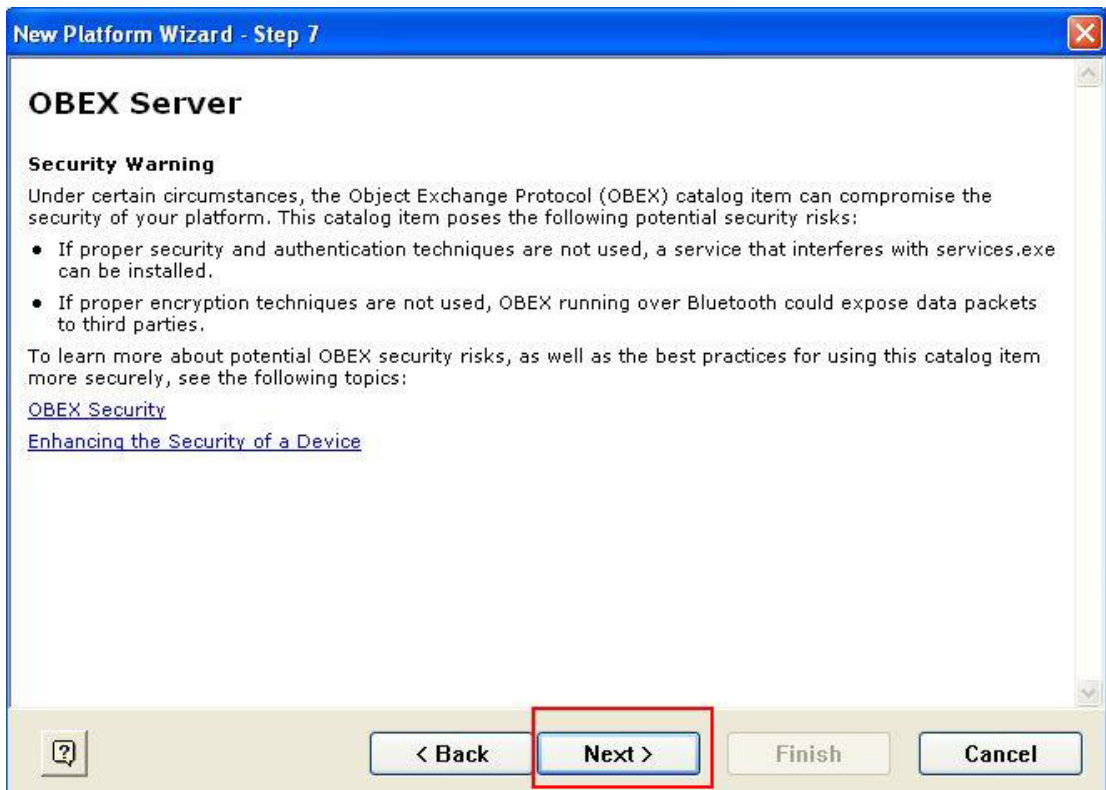
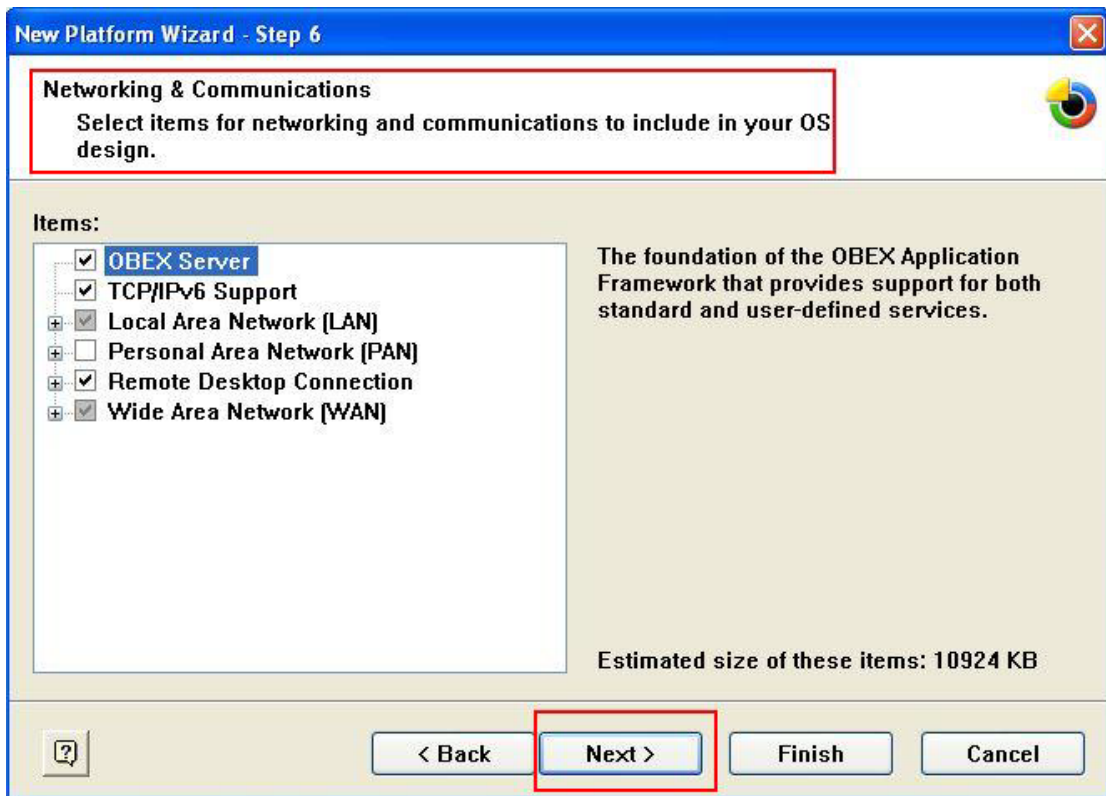

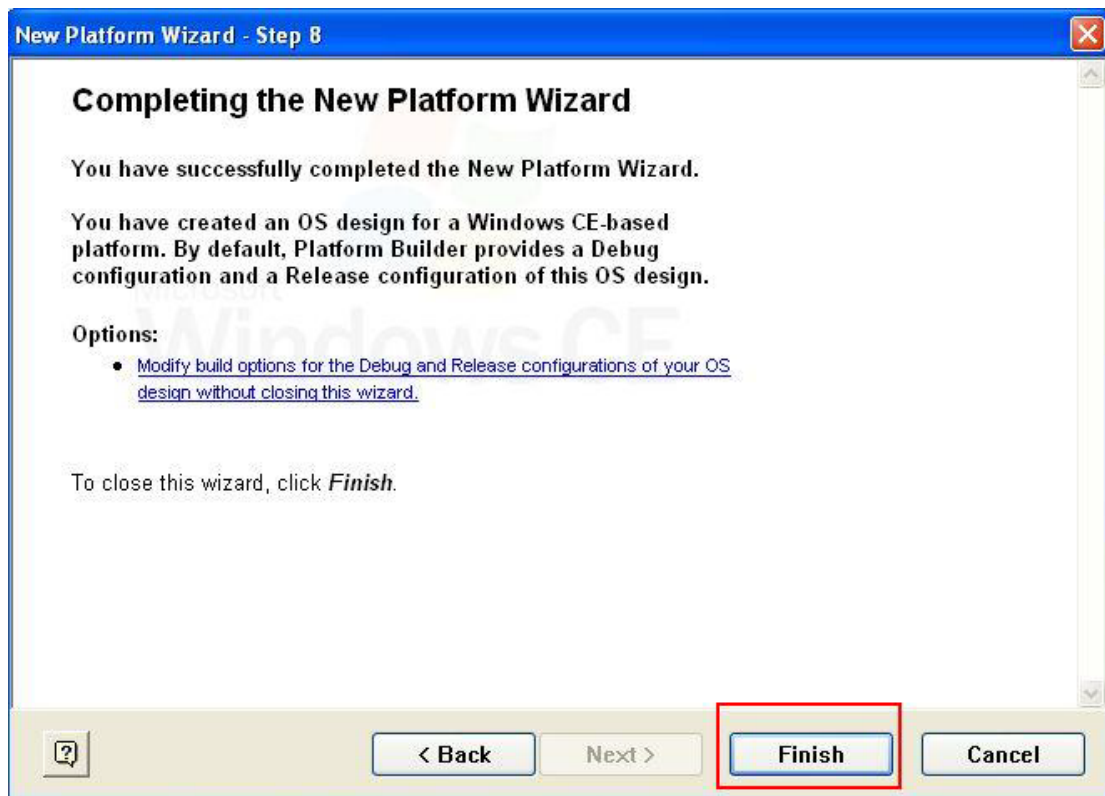

5. Open Manage Catalog Items (**File → Manage Catalog Items**). Under **Catalog (View → Catalog)**, browse `t\Third Party\Device Drivers\ MOXA Smartio/Industio-PCI, PC/104-Plus`. Right-click on the driver **Prefix COM** or **Prefix MXU** you would like to include and choose **Add to OS Design**.

**NOTE** You can only select either Prefix COM or Prefix MXU, but not both.

Prefix COM supports up to 10 ports, from COM0 to COM9. Prefix MXU supports more than 10 ports, so it is better to select Prefix MXU if you are not sure how many ports the device has. Otherwise, you will only be allowed to use one multiport serial board on the target host.

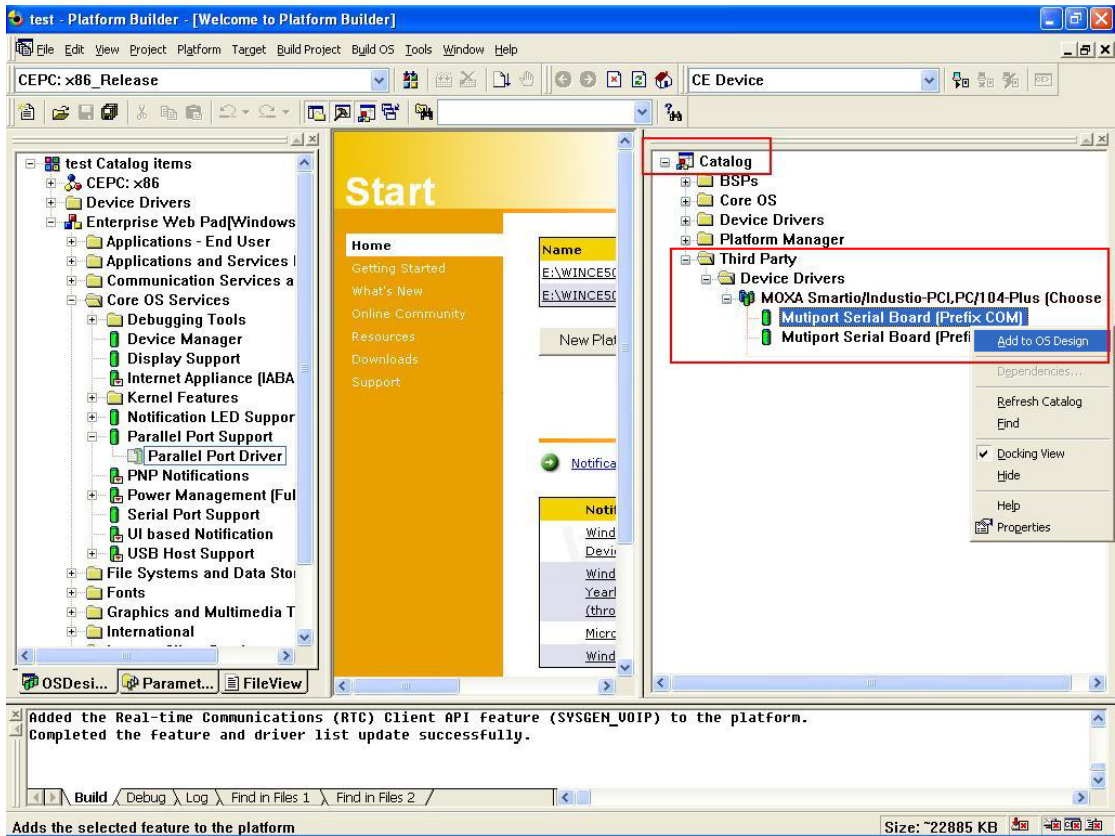

6. After adding Moxa Tech drivers into your **OS Design**, a new project is automatically added to your workspace. The project name is **mxserce5**. The project can be accessed from File View (**View** → **File View**). The **mxserce5** project contains a number of files used to configure the drivers included in your **OS Design**.

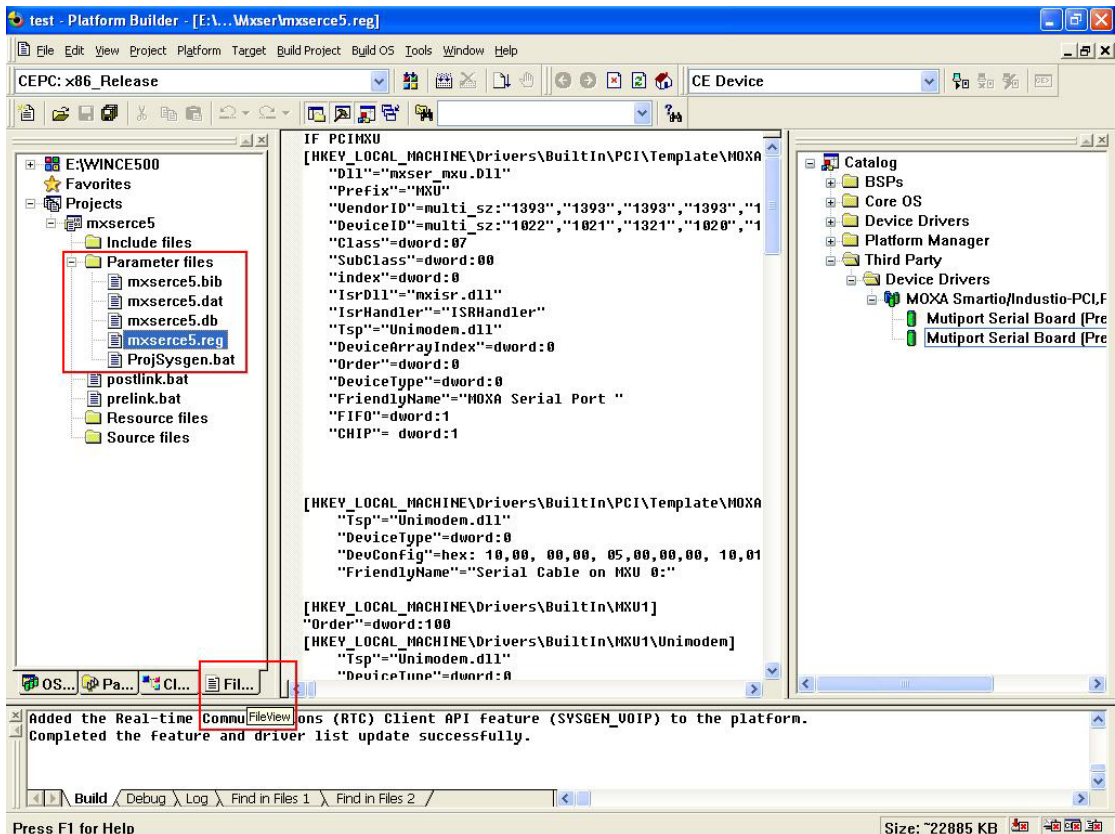

**NOTE** If you would like to use the "Terminal Emulator" tool, please modify mxserce5.reg and keyboard like below (This is only just for "one" "COM" port). You have to take note of the number of ports, COM, MXU, and enter the correct information.

```
[HKEY_LOCAL_MACHINE\ExtModems\HayesCompat1]
```

```
"Port"="COM2:"
```

```
"DeviceType"=dword:1
```

```
"FriendlyName"="Hayes Compatible on COM2:"
```

- Finally, open **Build OS**, select **Build and Sysgen**, and be sure to click **Copy Files to Release Directory After Build** and **Make Run-Time Image After Build**.

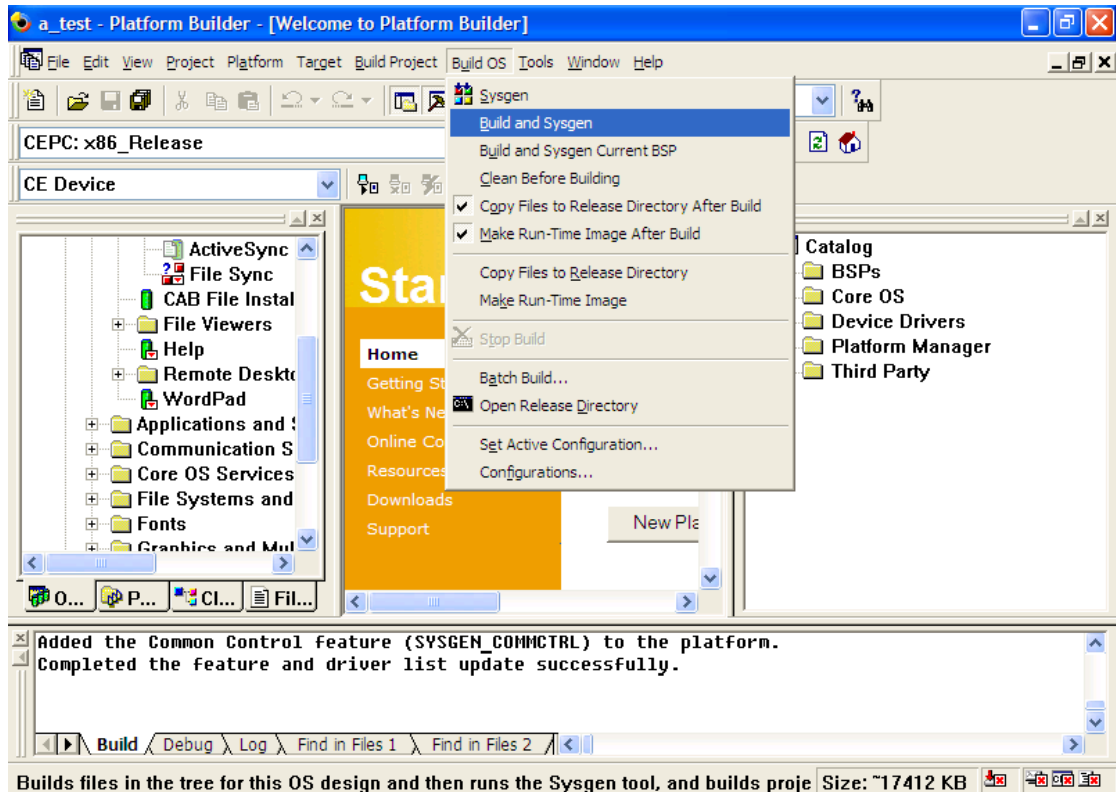

- Finally, copy your image file to the target host.

**NOTE** If you have created a Windows CE Platform Builder in the development environment, skip steps 2, 3, and 4..



## Newer OS for Both CA/CB Series

The content below will describe the software installation for newer Windows OS, including Windows 2000/XP/2003/Vista/2008/7/8/8.1/10 (x86/x64), Windows Server 2008 R2/2012/2012 R2/2016 (x64)

The following topics include

- Installing the Driver
- Configuring the Ports
- Checking the Status
- Removing the Driver
- Uninstallation the Driver

We will take Window 7 (x64) for example, to let you know how to install your CA or CB boards. The installation procedure of Windows7 is similar to the other Windows platforms. The content describes how to install, configure, check the port status, remove, or uninstall the CA or CB boards.

**NOTE** In the installation section, the CA Series has more installation procedures as it follows the ISA standard. The content will be added, followed by the installation part of CB Series.

### Installing the Driver

In this section, we will describe how to install the CA or CB boards for the first time with Windows 7.

First, make sure that you have already plugged the board or boards into the system's PC/104 or PC/104-Plus slot(s).

**NOTE** If you have already installed Moxa CA or CB board(s) in your computer, and you are installing additional boards, Windows 7 will automatically detect and install the new board(s) the next time you boot up the computer. In this case, proceed directly to the next section, "Configuring the Ports," to configure the ports' serial transmission parameters.

Second, download the drivers at [www.moxa.com](http://www.moxa.com). Based on the OS type, choose the corresponding driver.

Then, follow the following procedures to install the driver.

1. The Setup Wizard will open. Click **Next** to install the driver.

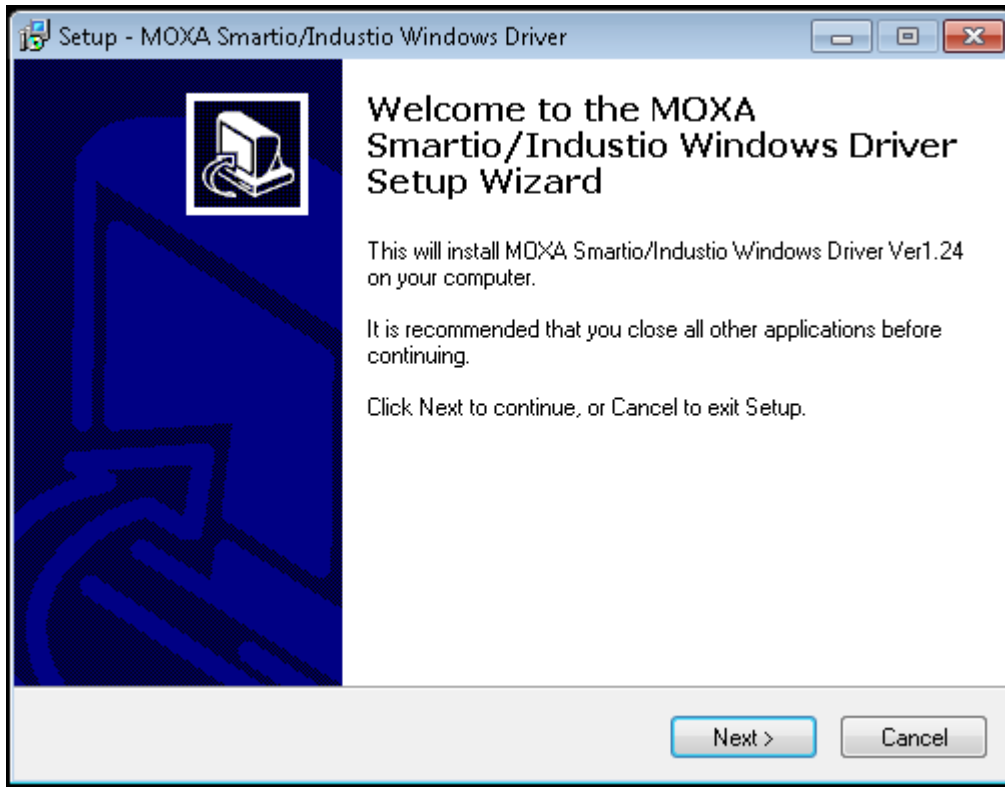

2. Please read the license agreement. If you agree, click **Next** to move on.

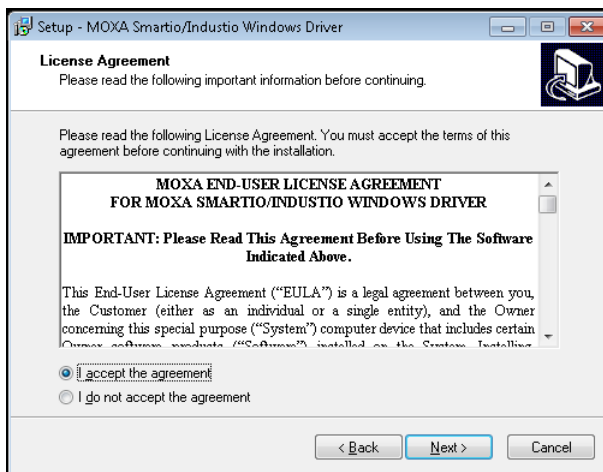

3. Click **Next** to install the driver in the indicated folder, or use the drop-down folder list to locate a different folder.

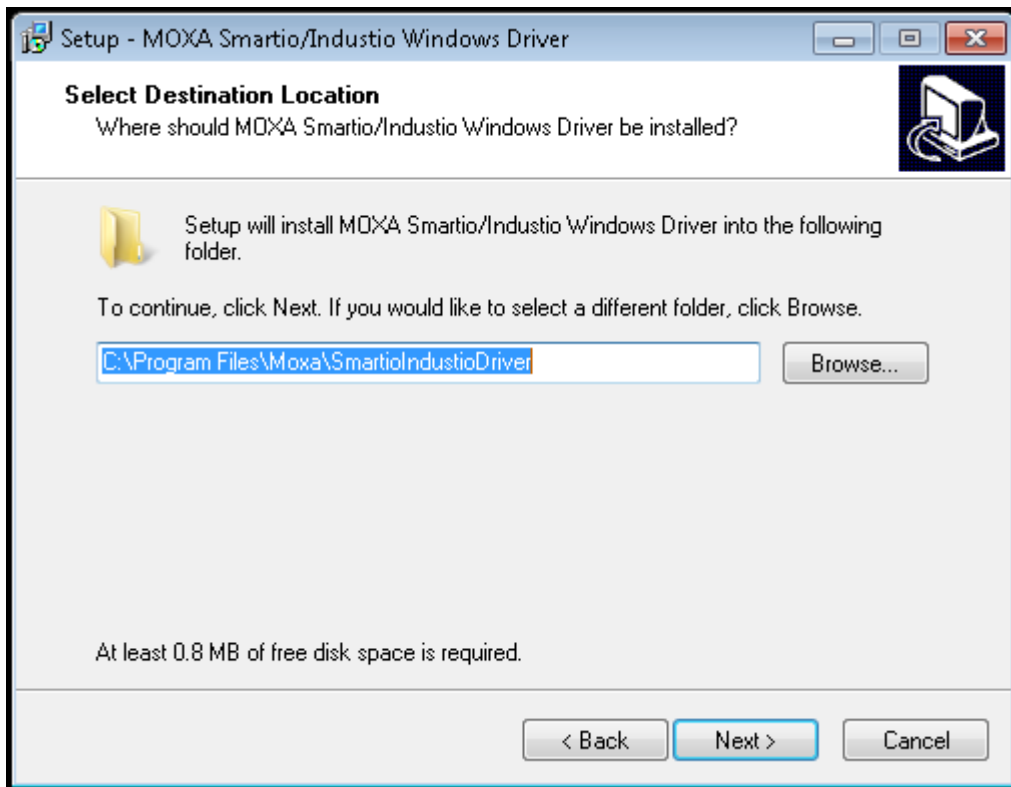

4. Click **Install** to proceed with the installation.

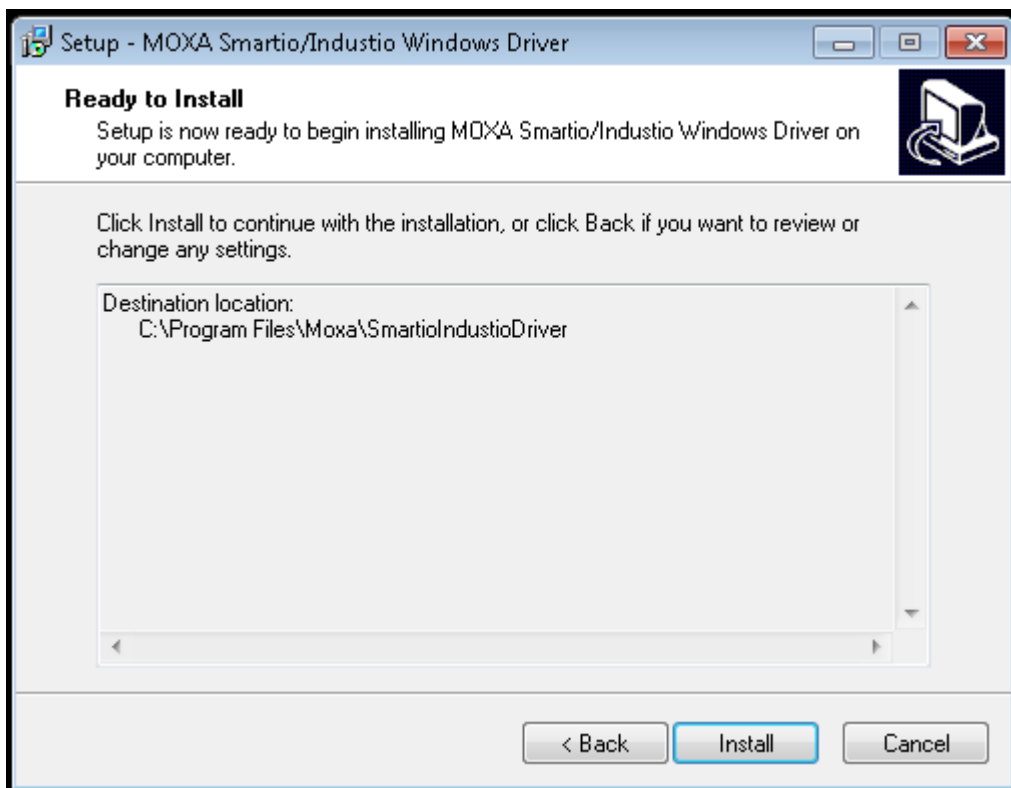

5. Click **Finish** to complete the installation of the driver.

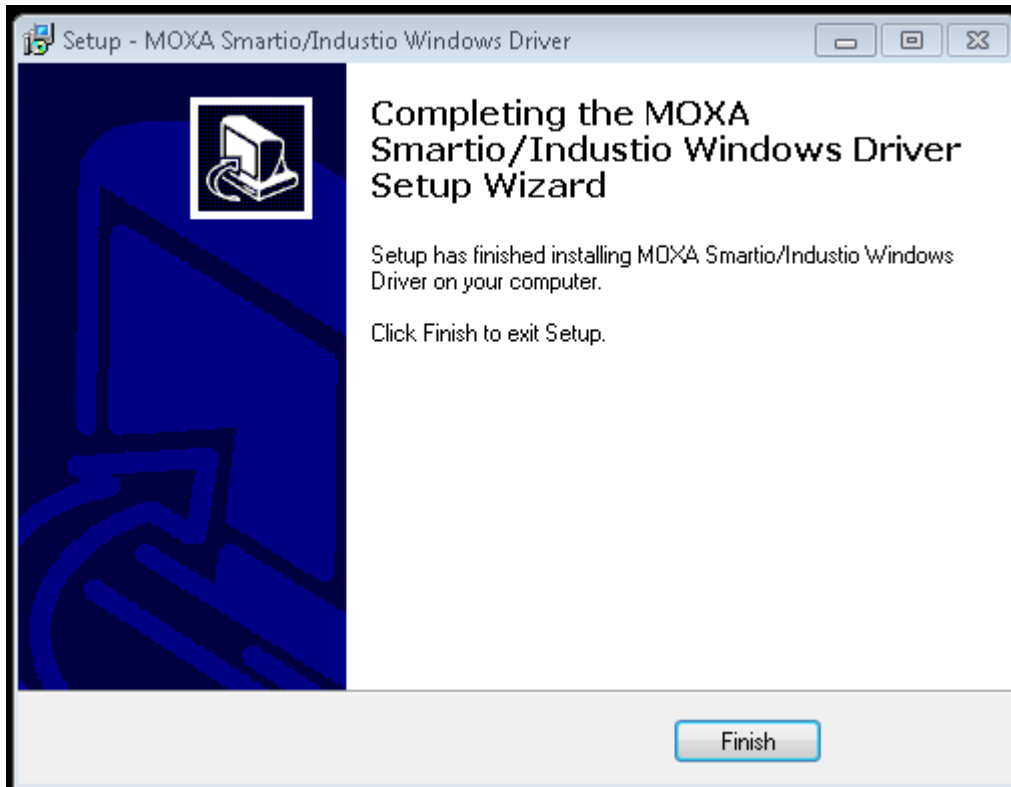

If your model is from the CB Series, then the installation is done. Otherwise, you need to do the following steps to complete the installation for the CA Series (CA-114 Series is taken as example).

1. Select **Add Hardware Wizard** from the Control Panel. When the wizard opens, click **Next** to continue.



2. Select **Yes, I have already connected the hardware** and click **Next** to continue.

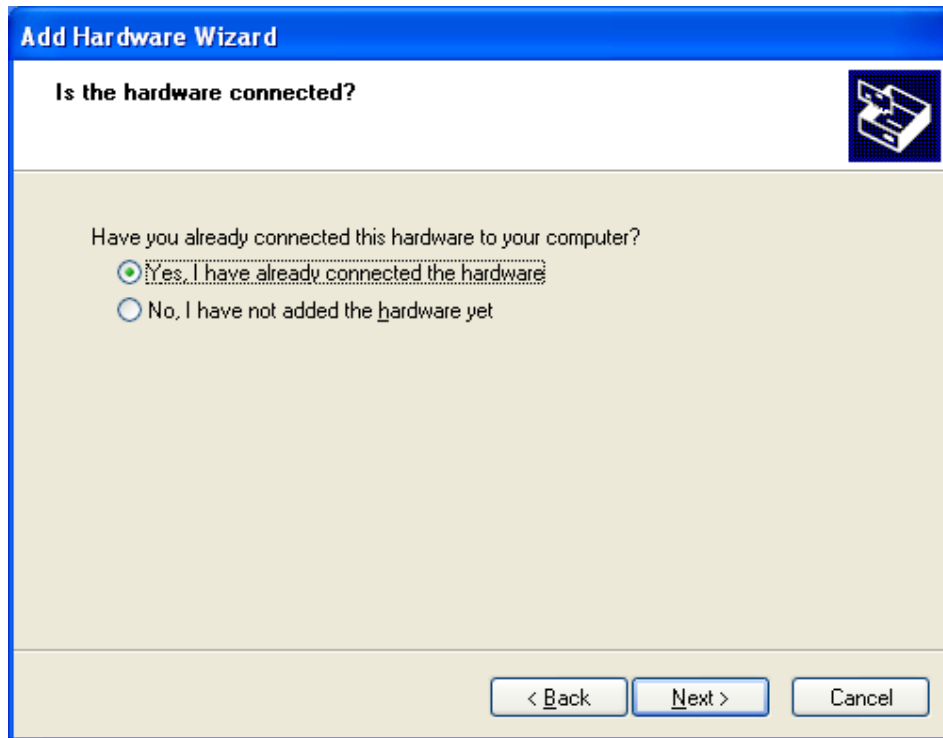

3. Select **Add a new hardware device** and click **Next** to continue.

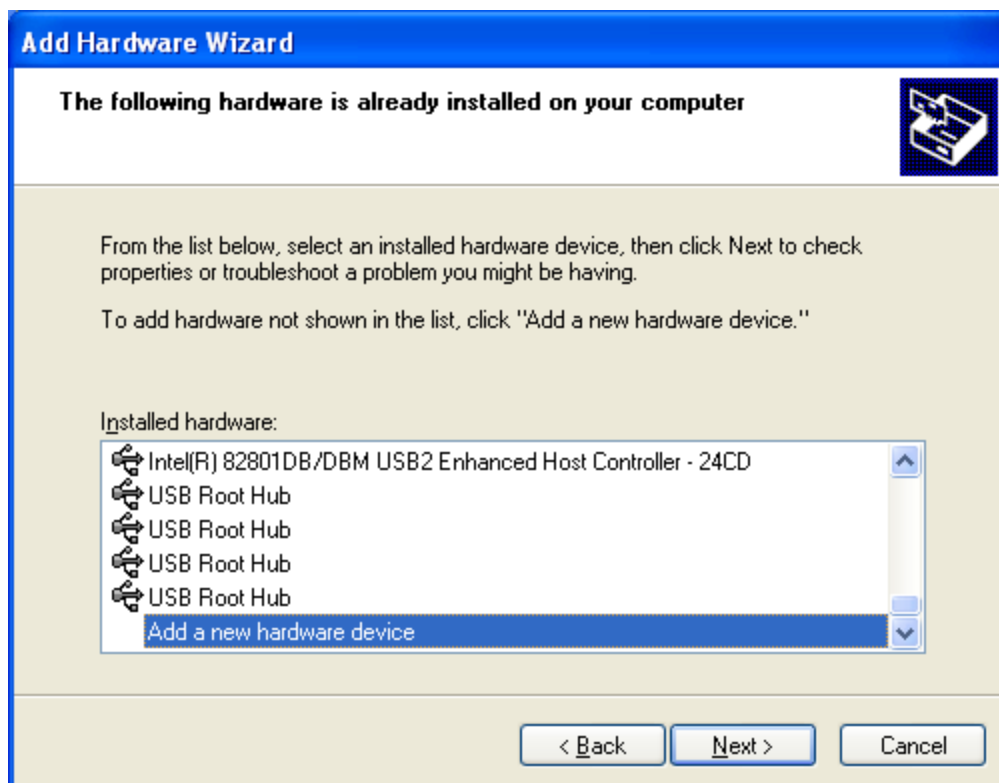

4. Select **Install the hardware that I manually select from a list (Advanced)** and click **Next** to continue.

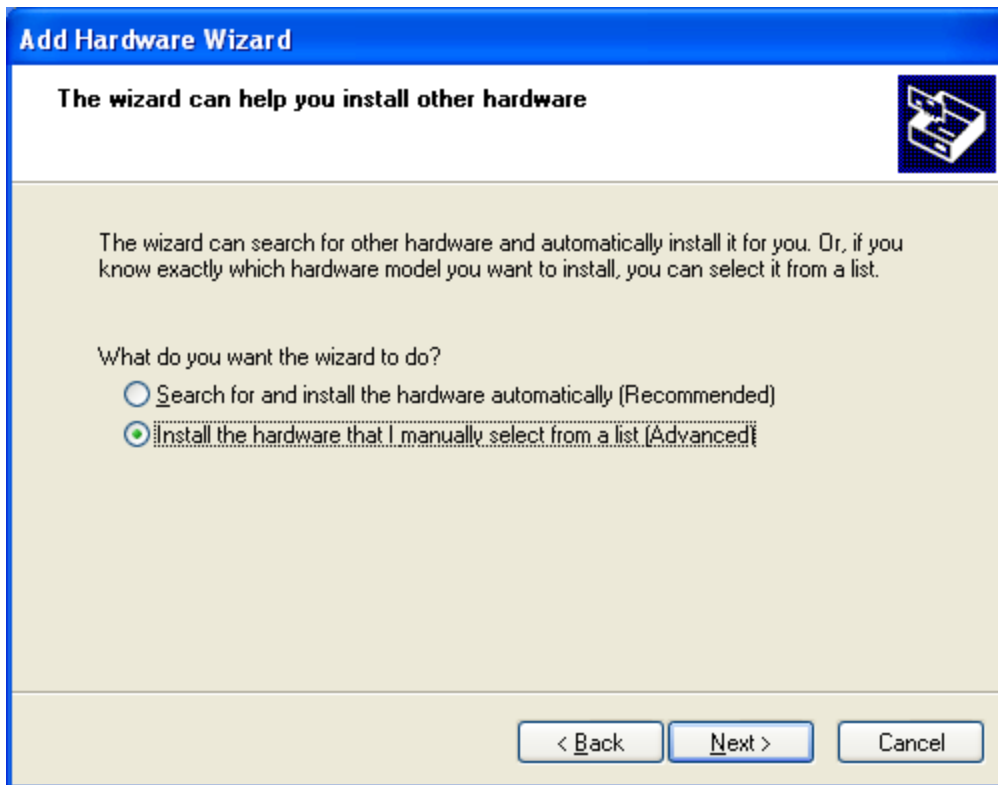

5. Select **Multi-port serial adapters** and click **Next** to continue.

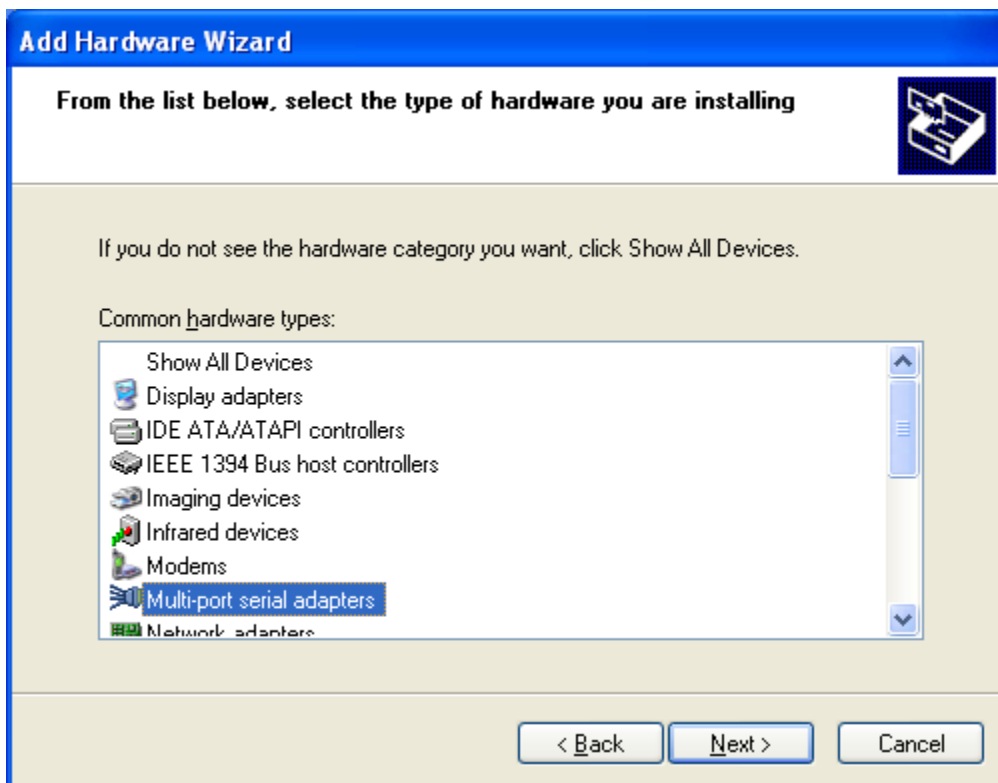

6. Select your CA Series model and click **Next** to continue.



7. To begin installing the module, click **Next**.

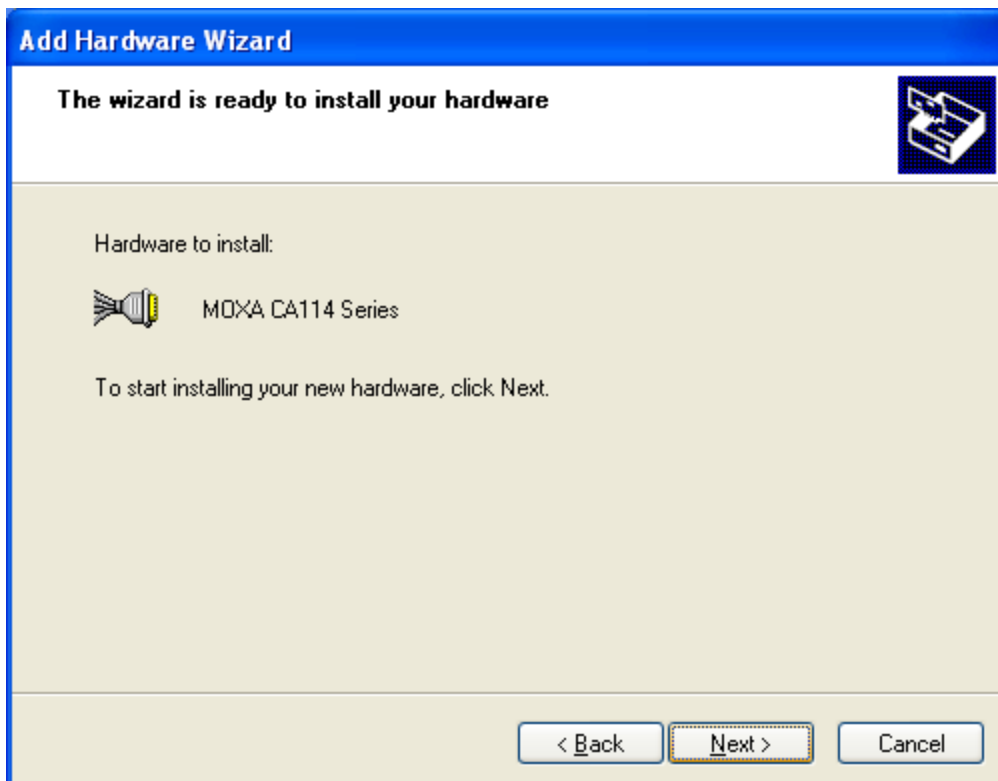

- 8. If you see a warning that the software has not passed Windows Logo testing, click **Continue Anyway**.



- 9. Windows will install the drivers. When the installation has been completed, click **Finish**.

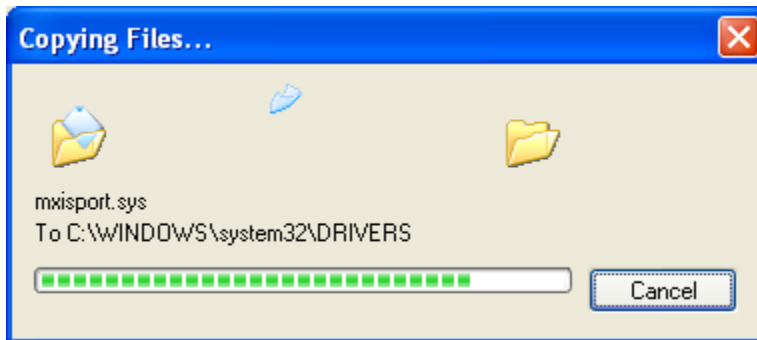



- After the module has been installed, you will be prompted to install the new serial ports. A **Found New Hardware Wizard** window will open for the first serial port, port 0. Select **No, not this time** and click **Next**.



- Select **Install from a list or specific location (Advanced)** and click **Next**.

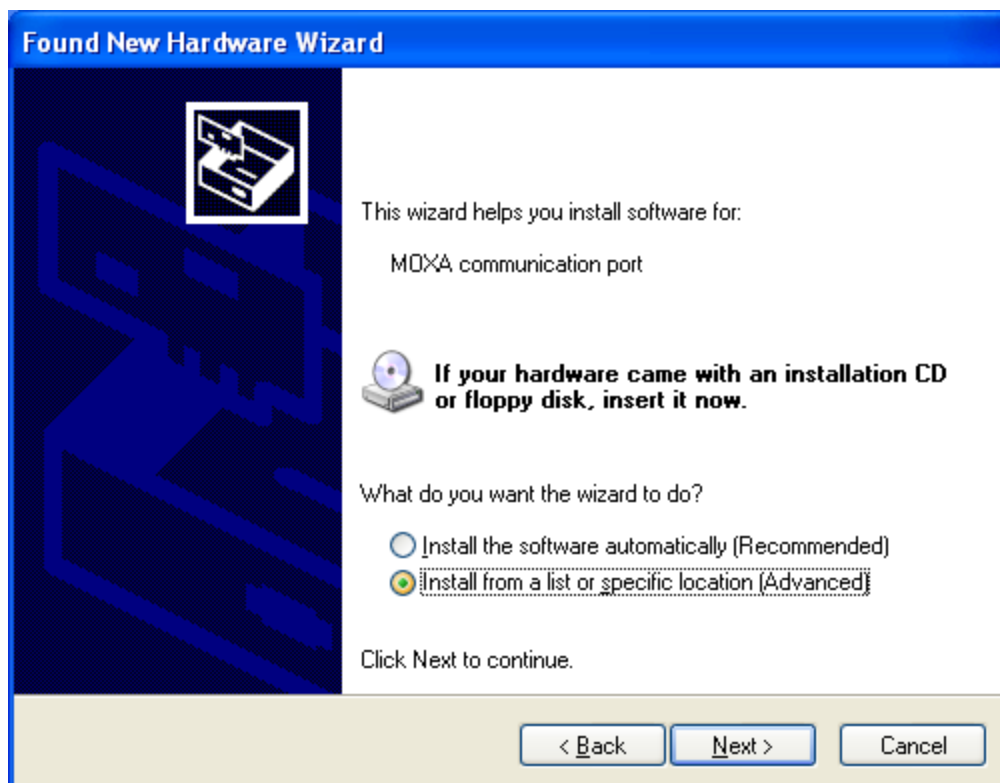

12. Select **Search for the best driver in these locations** and **Include this location in the search**.  
 Select the `\Program Files\MOXA\SmartioIndustioDriver` folder on the C drive disk, and click **Next**.

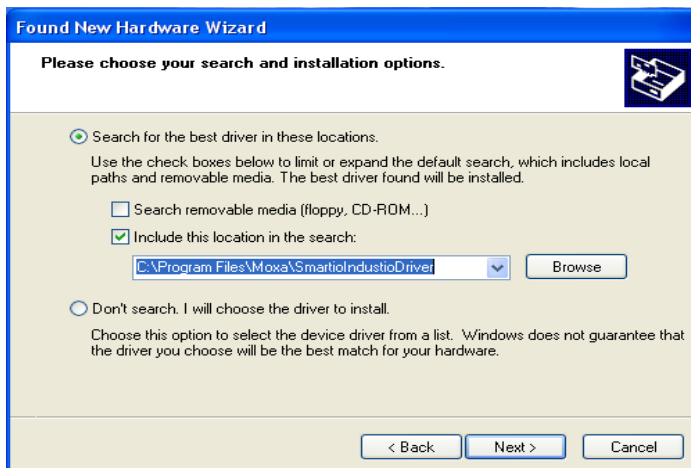

13. If you see a warning that the software has not passed Windows Logo testing, click **Continue Anyway**.



- 14. Windows will install the necessary drivers.

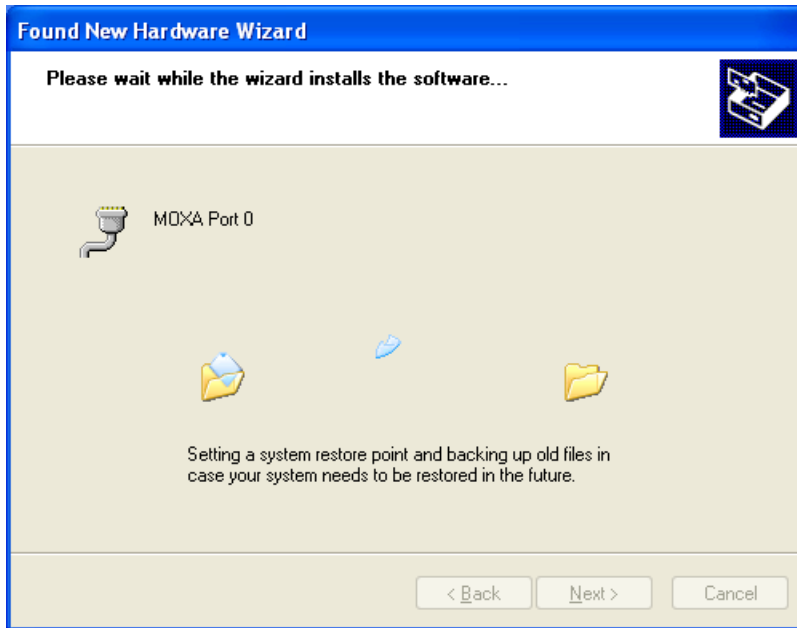

- 15. After the installation is complete, click **Finish**.

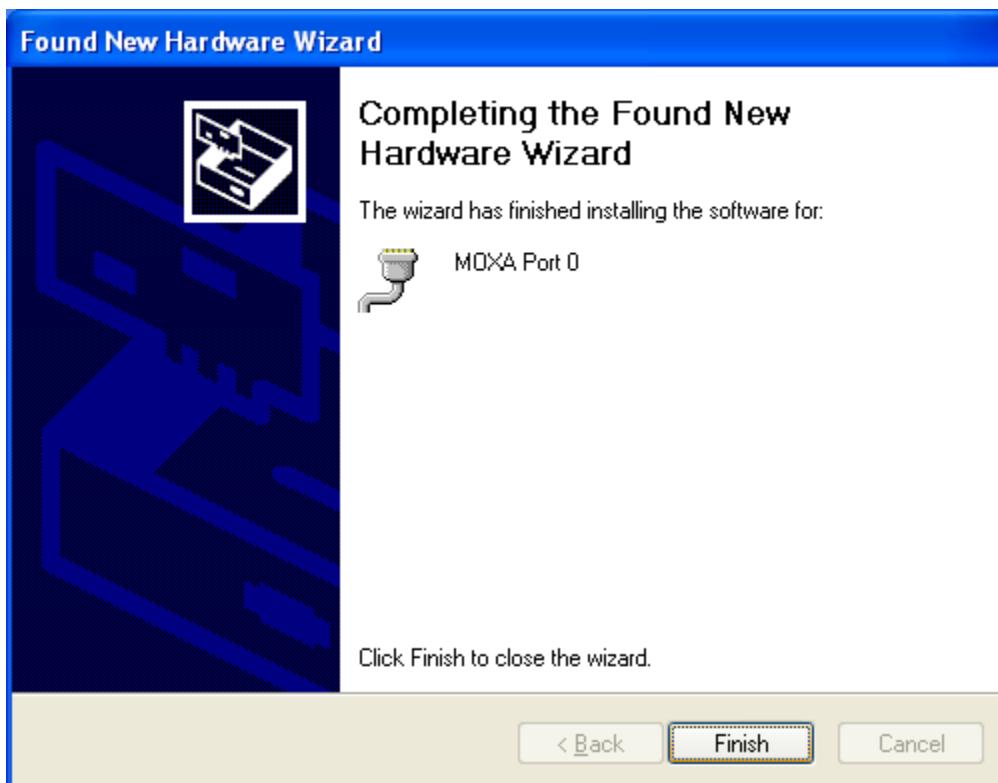

- 16. Repeat the installation process for the remaining serial ports.

## Configuring the Ports

After the driver has been installed, use Device Manager to configure the serial port of your CA or CB boards (CB-134I Series will be used as example).

In this section, we describe how to access MOXA Smartio/Industio Window Driver and lead you to do the serial port configuration.

- Accessing MOXA Smartio/Industio Window Driver
- Configuring Serial Port
  - Port Number
  - Rx, TX FIFO

### Accessing MOXA Smartio/Industio Window Driver

Expand the **Multi-port serial adapters** tab, right-click **CB-134I Series (PC/104-Plus)**, and then click **Properties** to open the board's configuration panel.

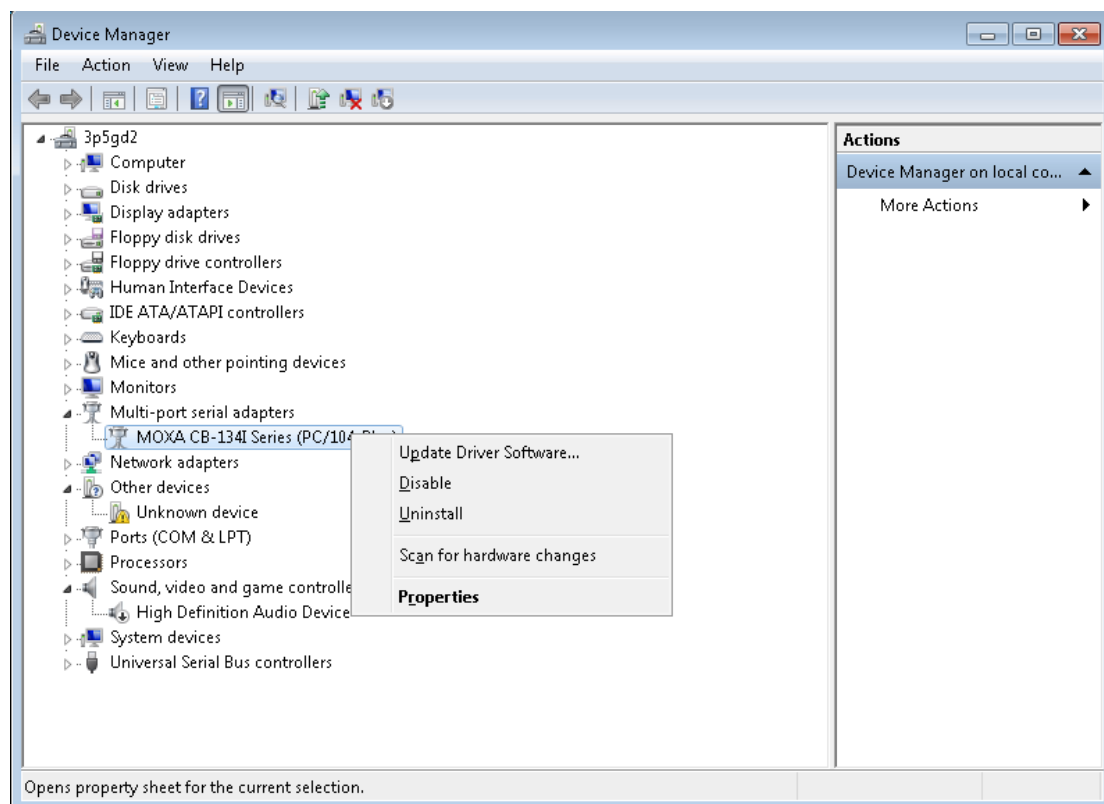

## Configuring the Serial Ports

### Port Number

1. Click the port you would like to configure to highlight it and then click **Port Setting**.

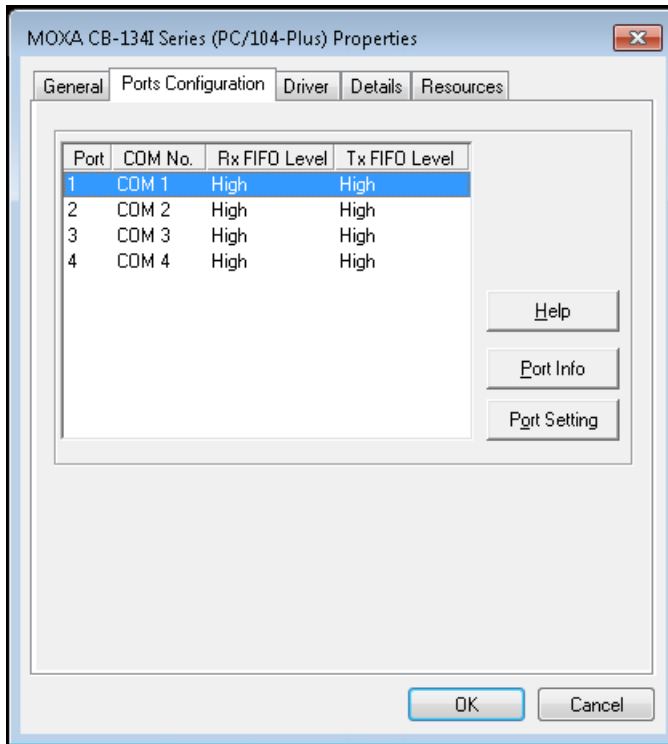

2. Select a COM number for the port from the **Port Number** pull-down list. Select the **Auto Enumerating COM Number** option to map subsequent ports automatically. The port numbers will be assigned in sequence. For example, if COM 1 is assigned to Port 1, then COM 2 (if not already occupied) will be assigned to Port 2, etc.

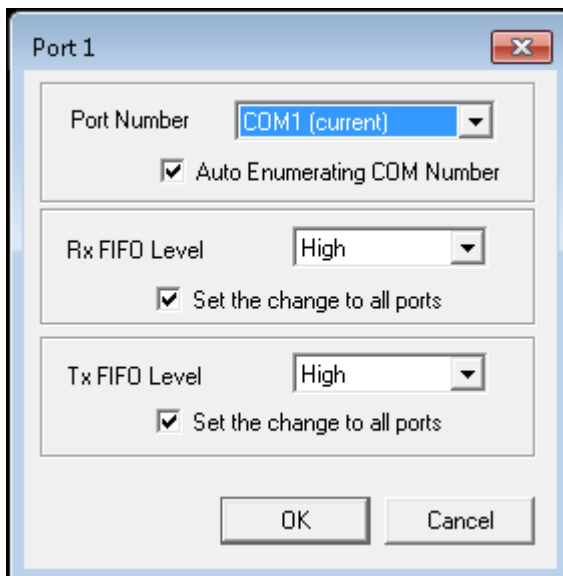

**Rx, TX FIFO**

1. Select an **Rx FIFO** Trigger from the **Rx FIFO Level** pull-down list. Rx FIFO trigger levels of **High**, **Middle**, and **Low** are available, with the default set to High. Select the **Set the change to all ports** option to apply this Rx FIFO Trigger to all ports.
2. Select a **Tx FIFO Level** from the **Tx FIFO Level** pull-down list. Tx FIFO Levels of **High**, **Middle**, and **Low** are available, with the default set to High. Select the **Set the change to all ports** option to apply the just defined Tx FIFO Size to all ports.

	Tx FIFO (Byte)		Rx FIFO (Byte)	
	CA Series	CB Series	CA Series	CB Series
High	64	128	56	120
Middle	32	64	28	60
Low	1	1	1	1

3. Click **OK** to save the port settings and then click **OK** in the **Property** window to finish the port settings procedure.

**Checking the Status**

The PComm Diagnostic program is a useful tool to check the status of Moxa’s multiport serial boards. The program can be used to test internal and external IRQ, TxD/RxD, UART, CTS/RTS, DTR/DSR, etc. Use this program to ensure that your Moxa boards and ports are working properly.

To start the program, click **Start→ Programs→ MOXA→ PComm Ver 1.X→ PComm Diagnostic**

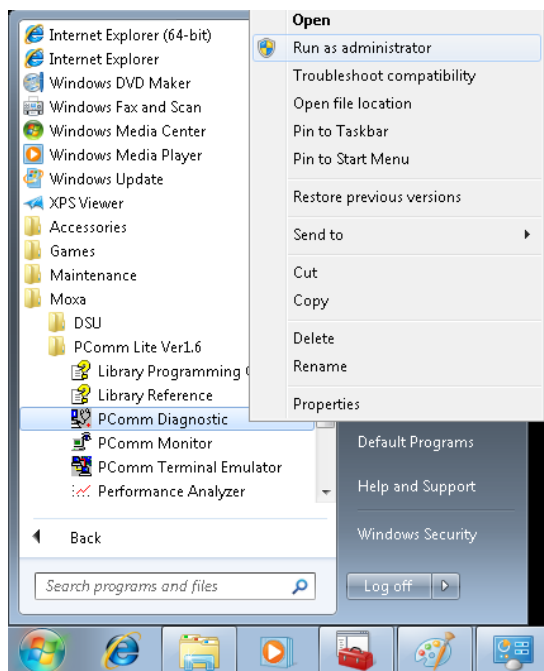

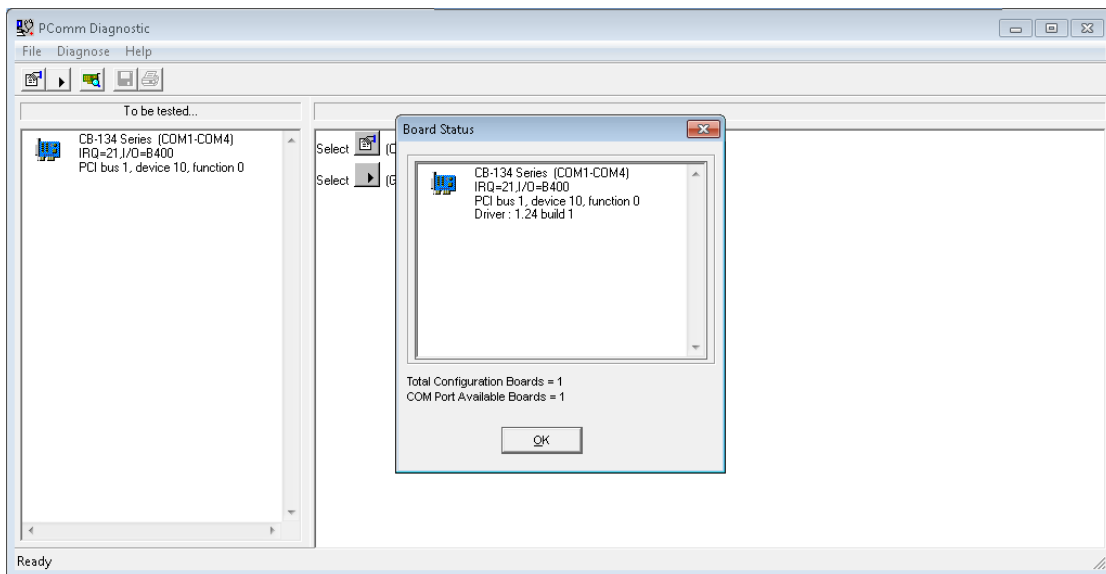

**NOTE** You can download the PComm Lite software for free from Moxa's website at [www.moxa.com/support/free\\_downloads.htm](http://www.moxa.com/support/free_downloads.htm).

## Removing the Driver

1. Open the Device Manager and use the mouse to place the cursor over the **MOXA CB-134I Series (PC/104-Plus boards)** under Multi-port serial adapters, right-click, and then select the Uninstall option.

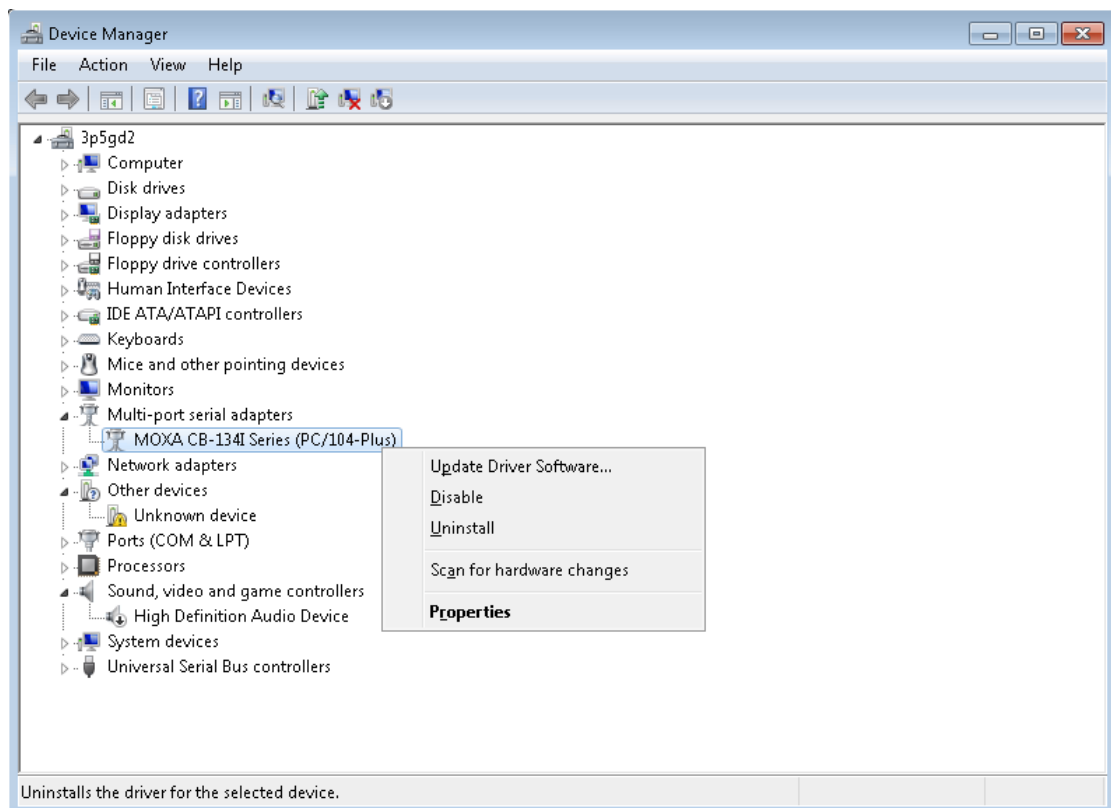

2. Select **Delete the driver software for this device** and click **OK** to proceed with uninstalling the board.

## Uninstalling the Driver

The MSB driver may be removed through Add/Remove Programs in the Windows Control Panel. Click **Uninstall** next to **MOXA Smartio/Industio Windows Driver Verx.xx**

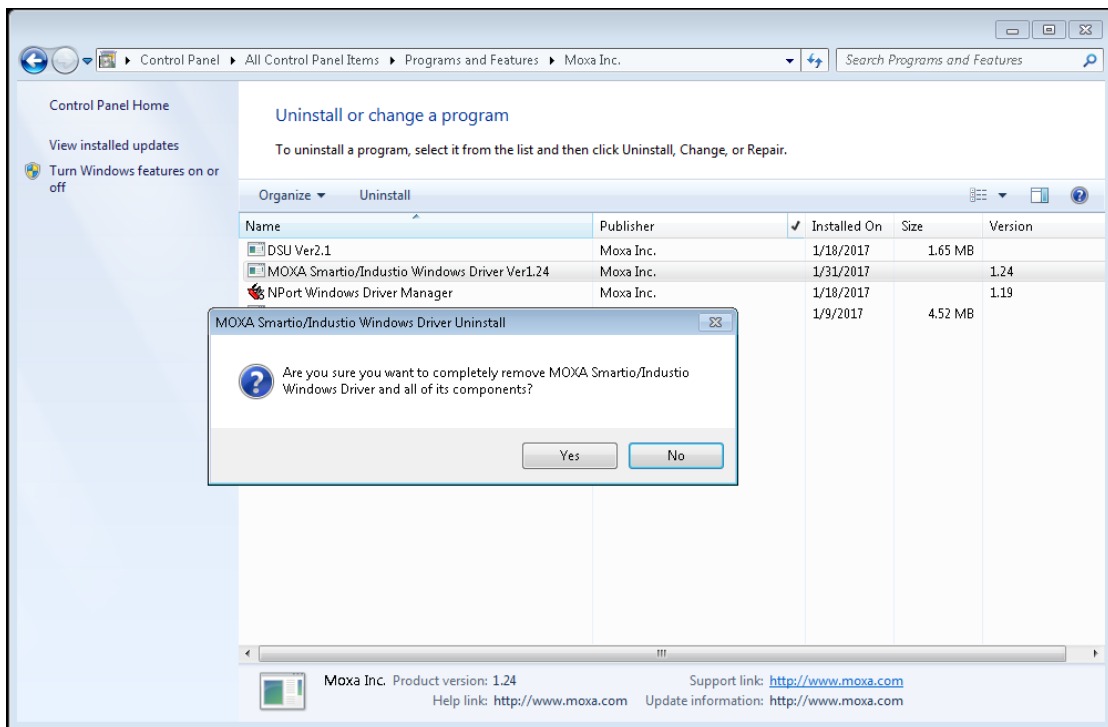
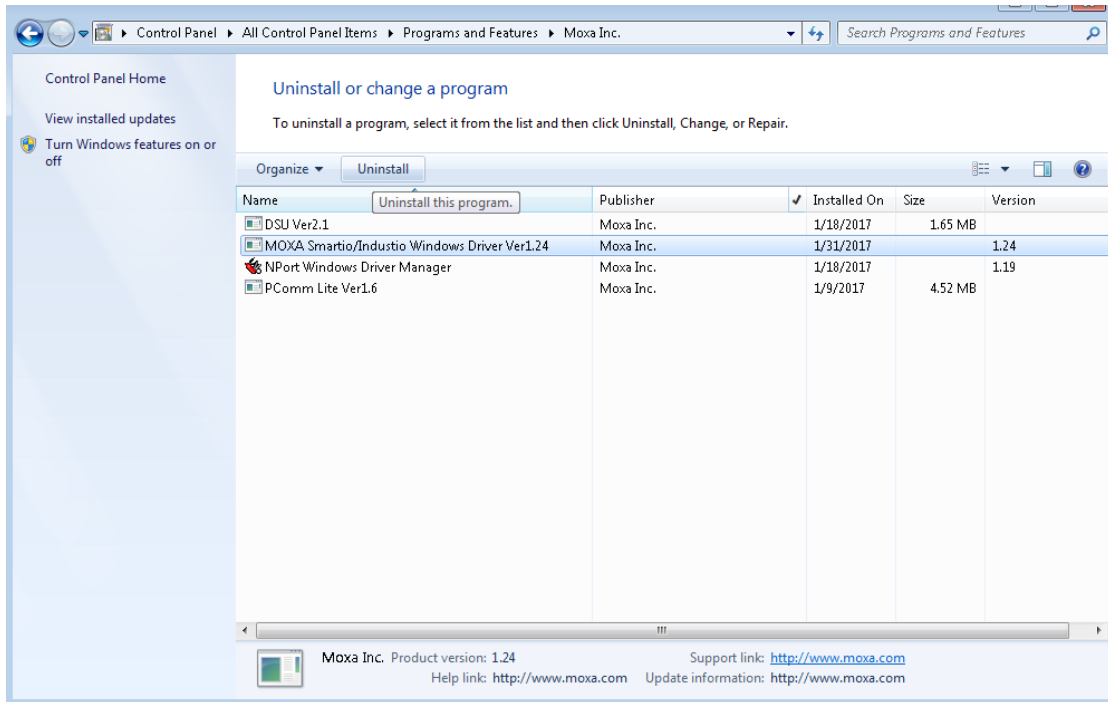



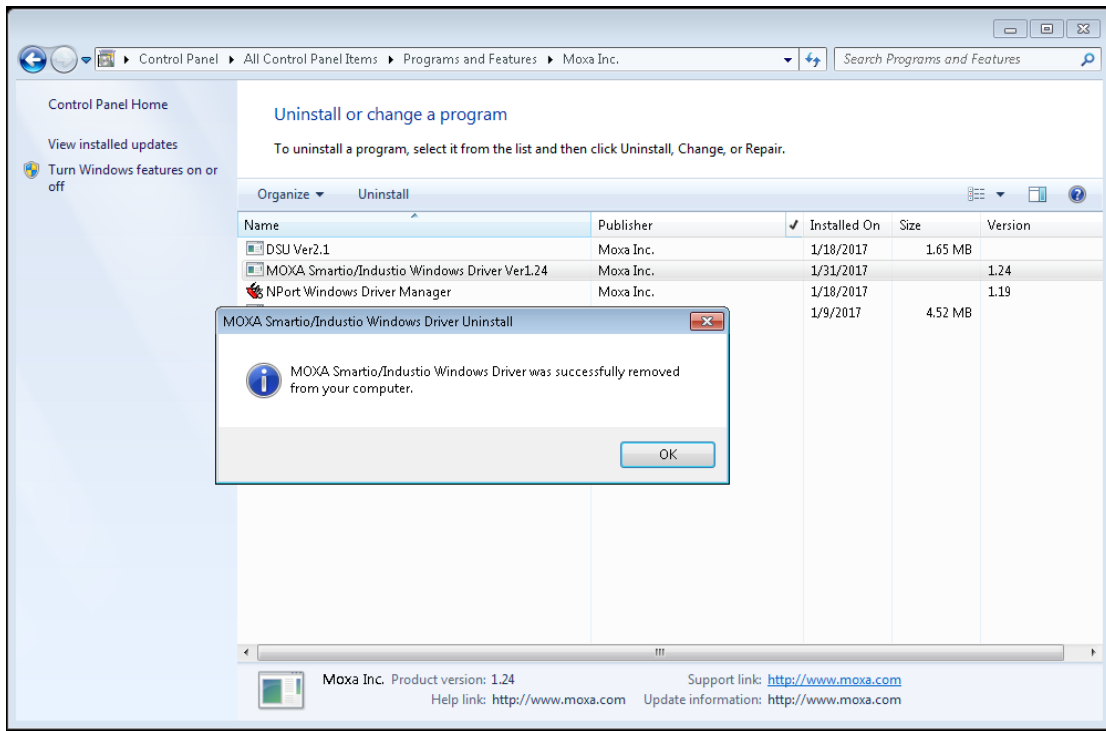

## Non-Windows OS

### Linux

- Execute the following commands from the Linux prompt:
 

```
#cd /
#mkdir moxa
#cd moxa
#cp /<driver
directory>/driv_linux_smart_<version>_build_<build_date>.tgz .
# tar -zxvf
driv_linux_smart_<version>_build_<build_date>.tgz# #cd mxser
```
- ```
#cd /moxa/mxser/driver
#./mpmknod
```
- Install the module driver using the hardware settings that you selected. For example, for an I/O address of 0x180, an INT vector of 0x1C0, and an IRQ of 10, execute the following command:
 

```
#modprobe mxser ioaddr=0x180 iovect=0x1C0 irq=10
```

 (This step is only for CA Series)
- You can use the Moxa diagnostic utility to verify the driver's status:
 

```
#cd /moxa/mxser/utility/diag
#./msdiag
```
- You can use the Moxa terminal utility to test the TTY ports:
 

```
#cd /moxa/mxser/utility/term
#./msterm
```

# Serial Programming Tools

---

Moxa provides Windows serial programming libraries and troubleshooting utilities that are easy to use and powerful. You can use these tools to reduce software development time.

The serial communication library is useful for developing applications for data communications, remote access, data acquisition, and industrial control. It provides a simpler solution compared to the more complex Windows Win32 COMM API.

PCComm is a professional serial communication tool for Windows PCs. PCComm includes the following features:

- Useful utilities for diagnostics, port monitoring, and terminal emulation
- Sample programs
- Comprehensive help files

The following topics are covered in this chapter:

▣ **Serial Programming Library**

▣ **PCComm Utilities**

- Installation
- PCComm Diagnostic
- PCComm Monitor
- PCComm Terminal Emulator

# Serial Programming Library

The serial programming library assists you in developing serial communications programs for any COM port that complies with the Microsoft Win32 API. It facilitates the implementation of multi-process and multi-thread serial communication programs and can remarkably reduce development time.

The library provides a complete set of functions as well as various sample programs for Visual C++, Visual Basic, and Delphi. To view detailed descriptions of the available functions and sample programs, go to **Start → Program → PComm Lite** and select **PComm Lib Help**, **PComm Porting Notes**, or **PComm Programming Guide**. You may also refer to the sample programs in the PComm directory.

## PComm Utilities

This sections provides brief descriptions of the PComm utilities. For more information about these utilities, please refer to the help files or to the API-232.txt file for DOS.

## Installation

To install PComm, run **Setup.exe** from the installation diskette. Please note that the PComm diagnostic and monitor utilities are for Moxa boards only. These two utilities will not work with other serial boards.

## PComm Diagnostic

PComm Diagnostic is designed for Moxa boards only. It provides internal and external testing of IRQ, TxD/RxD, UART, CTS/RTS, DTR/DSR, DTR/DCD, and other items. You can use PComm Diagnostic to check the operation of both software and hardware.

To run the Diagnostic program, go to **Start → Program → PComm Lite → Diagnostic**.

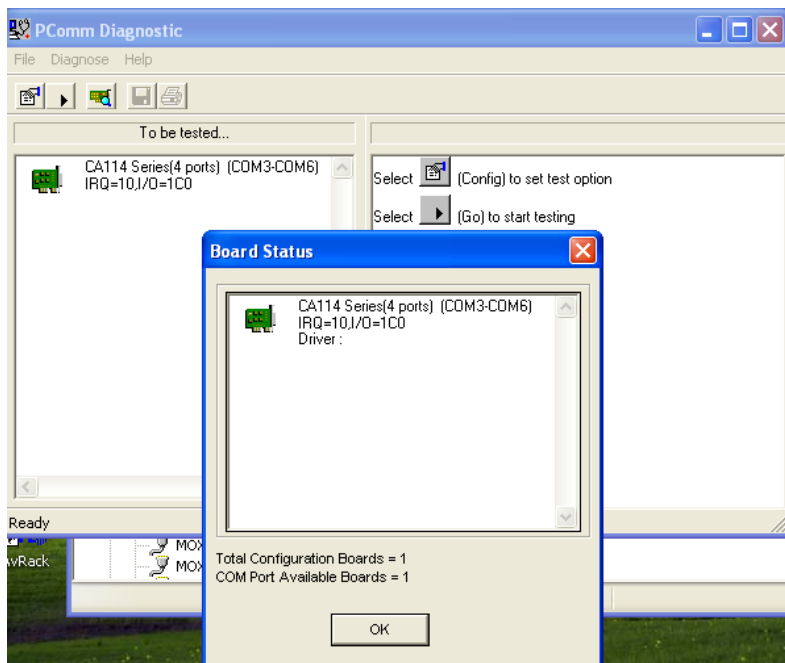

## PComm Monitor

PComm Monitor is designed for Moxa board in Windows NT only. It allows you to monitor data transmission of selected Moxa COM ports. It monitors data transmission, throughput, and line status at regular intervals. Click on a specific port to view that port's communication parameters and status.

To run PComm Monitor, go to **Start → Program → PComm Lite → Monitor**.

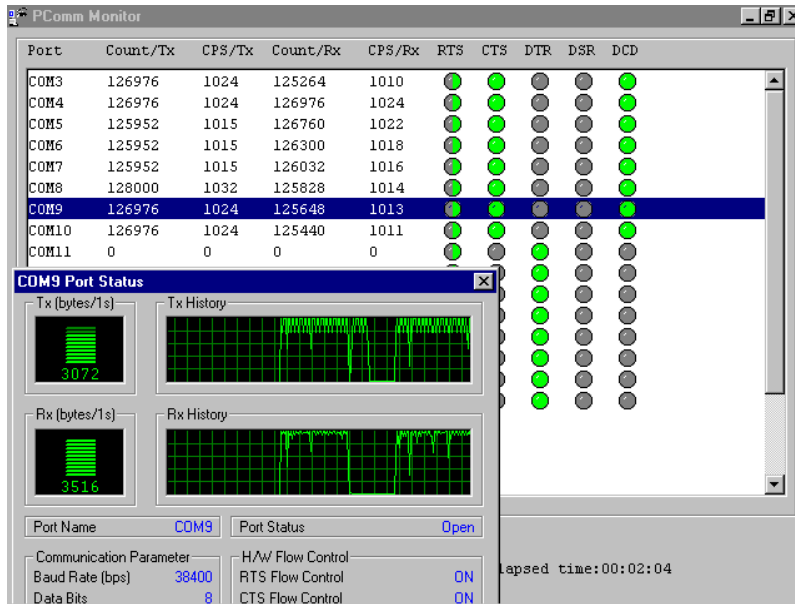

## PComm Terminal Emulator

PComm Terminal Emulator can be used to connect to a serial port to verify that data transmission is functioning correctly. It supports multiple windows and both VT100 and ANSI terminal types. You can interactively transfer data, periodically send patterns, and transfer files using ASCII, XMODEM, YMODEM, ZMODEM, and KERMIT protocols.

To run PComm Terminal Emulator, go to **Start → Program → PComm Lite → Terminal Emulator**.

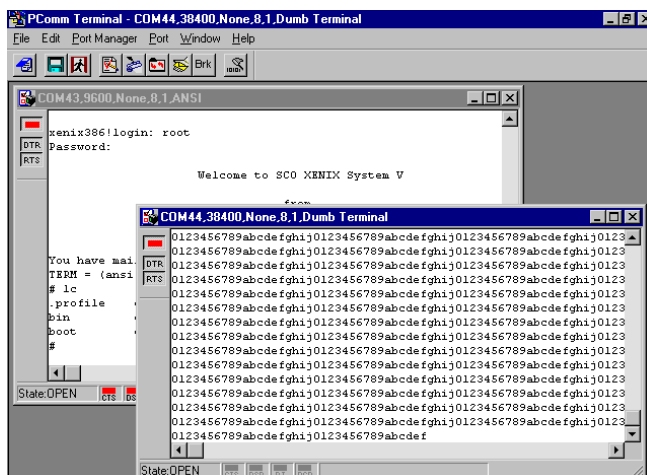

## Smartio/Industio Programming Guide

---

If you want to develop your own driver, no matter whether it is on a Windows or Linux platform, Moxa Smartio/Industio Programming Guide is very useful.

The following topics are covered in this chapter:

- ❑ **Relative Product List**
- ❑ **Resource Requirement for Moxa Board**
- ❑ **PCI Configuration for Moxa Board**
- ❑ **UART Register Structure for MU860 chip**
- ❑ **UART Register Structure for MUE250, MUE450, and MUE850 chips**
- ❑ **For Baud Rate Setting**
- ❑ **Moxa Board PCI Device ID List**
- ❑ **UART Datasheet**

## Relative Product List

Please see the "Moxa Board PCI Device ID List" at the end of this document.

## Resource Requirement for Moxa Board

IRQ \* 1

I/O :

UART register: 64 bytes (8 bytes/port \* 8port) for MU860

4096 bytes (512 bytes/port \* 8port) for MUE250/450/850

IRQ Vector register:16 bytes (only 1 byte is used)

## PCI Configuration for Moxa Board

A. MOXA Vendor ID: 0x1393

B. Device ID: Please see the "Moxa Board PCI Device ID List" section

C. Hardware resources on the Device Configuration Register of the **PCI configuration space**:

| Resource Name                          | Chip                   | Address Offset |      | Size       |
|----------------------------------------|------------------------|----------------|------|------------|
| IRQ                                    | All                    | 0x3C           |      |            |
| IRQ Vector Address                     | MU860                  | 0x1C           | BAR3 | 16 bytes   |
| UART register<br>(I/O Base Address)    | MU860                  | 0x18           | BAR2 | 64 bytes   |
| UART register<br>(Memory Base Address) | MUE250, MUE450, MUE850 | 0x14           | BAR1 | 4096 bytes |
| Vector Base Address                    | MUE250, MUE450, MUE850 | 0x18           | BAR2 | 16 bytes   |

| Byte Offset | 0-7            | 8-15          | 16-23     | 24-31 |
|-------------|----------------|---------------|-----------|-------|
| 00h         | Vendor ID      |               | Device ID |       |
| 04h         | Command        |               | Status    |       |
| 08h         | ...            |               |           |       |
| 0Ch         | ...            |               |           |       |
| 10h         | BAR0           |               |           |       |
| 14h         | BAR1           |               |           |       |
| 18h         | BAR2           |               |           |       |
| 1Ch         | BAR3           |               |           |       |
| ...         | ...            |               |           |       |
| 3Ch         | Interrupt Line | Interrupt Pin | Reserved  |       |
| ...         | ...            |               |           |       |

**NOTE** For MUE250, MUE450, and MUE850 chips only:  
Memory mode is recommended for these chips to access UART. To use memory mode, the driver has to access the memory base address, which is located at BAR1.

# UART Register Structure for MU860 chip

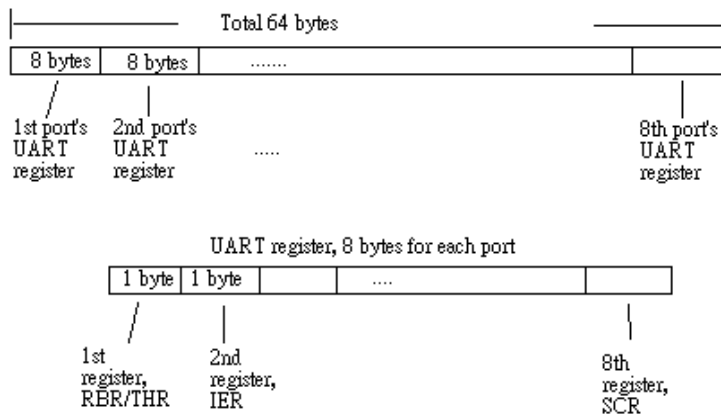

**NOTE** For a detailed UART register description, please see the "UART Datasheet" section..

- **UART register address = I/O base address + (port-1) \* 8**

For example, if the base address is 0x180:

The first port's UART registered I/O address is  $0x180 + (1-1) * 8 = 0x180$

The first registered I/O address is 0x180,

The second registered I/O address is 0x181, .....

The second port's UART registered I/O address is  $0x180 + (2-1) * 8 = 0x188$

The first registered I/O address is 0x188,

The second registered I/O address is 0x189, ...

- **IRQ Vector Register Structure**

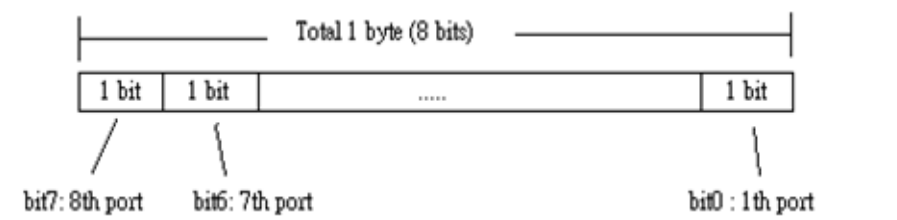

| Bit Value | Status                                                                                      |
|-----------|---------------------------------------------------------------------------------------------|
| 0         | Interrupt pending. Please read the UART register to get the detail interrupt information *. |
| 1         | No interrupt pending.                                                                       |

All serial ports on the same Moxa board use the same IRQ. Check the vector to determine which port issues the interruption. You can also get the information by querying the IIR of each port.

# UART Register Structure for MUE250, MUE450, and MUE850 chips

There are 512 bytes for each UART register and 0x200 offset between each port. However, there is one exception, for the models which are 4-port boards, such as **CP-104EL-A**, **CP-114EL**, **CP-114EL-I**, and **CP-134EL-A**, the offset of the fourth UART register is 0xE00.

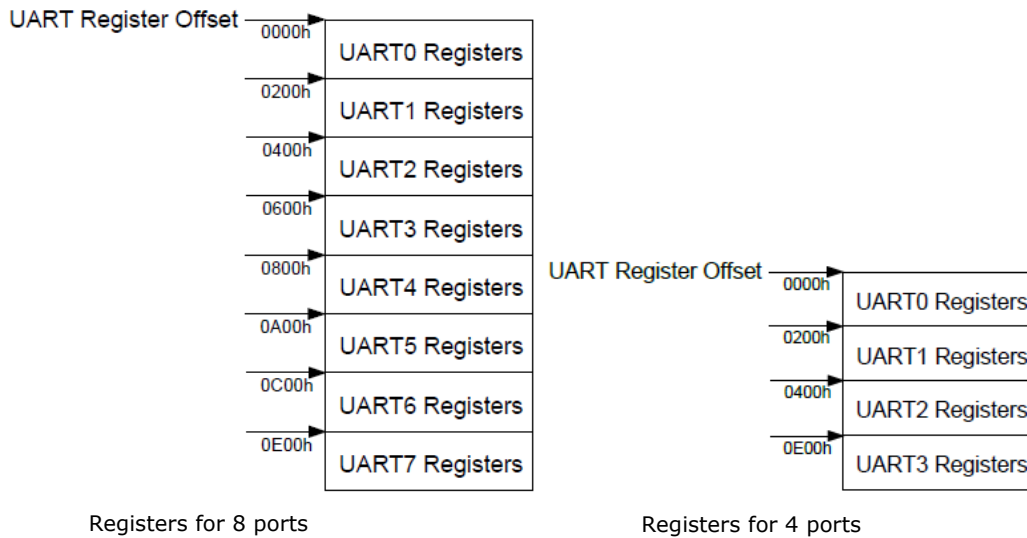

**NOTE** For a detailed UART register description, please see the "UART Datasheet" section..

- **UART register address = I/O base address + (port-1) \* 0x200**

For example, if base address is 0x200:

The first port's UART registered I/O address is  $0x200 + (1-1) * 0x200 = 0x200$

.....The first registered I/O address is 0x200,

The second registered I/O address is 0x201, .....

The second port's UART registered I/O address is  $0x200 + (2-1) * 0x200 = 0x400$

The first registered I/O register is 0x400,

The second registered I/O register is 0x401, .....

**NOTE** For CP-104EL-A, CP-114EL, CP-114EL-I, and CP-134EL-A only:  
 The first port's UART registered address: I/O base address  
 The second port's UART registered address: I/O base address + 1 \* 0x200  
 The third port's UART registered address: I/O base address + 2 \* 0x200  
 The fourth port's UART registered address: I/O base address + 7 \* 0x200Type note content here.



- **Control Serial Interface and Termination Resistor for MUE chips**

For Moxa boards that use MUE250, MUE450, and MUE850 chips, BAR2, which is allocated 16 bytes. is the vector base address that can be used to control the serial interface and termination resistor according to the following table.

| Offset | Bit    | Port # | Parameters                                                                                          |
|--------|--------|--------|-----------------------------------------------------------------------------------------------------|
| 0x4    | [3..0] | 1      | 0x0 : RS-232<br>0x1 : RS-422<br>0xF : RS-485 2W<br>0xB : RS-485 4W                                  |
|        | [7..4] | 2      |                                                                                                     |
| 0x5    | [3..0] | 3      |                                                                                                     |
|        | [7..4] | 4      |                                                                                                     |
| 0x6    | [3..0] | 5      |                                                                                                     |
|        | [7..4] | 6      |                                                                                                     |
| 0x7    | [3..0] | 7      |                                                                                                     |
|        | [7..4] | 8      |                                                                                                     |
| 0x8    | [7..0] | [8..1] | GPIO – Input                                                                                        |
| 0x9    | [7..0] | [8..1] | GPIO direction configuration<br>0 : Set GPIO direction to input<br>1 : Set GPIO direction to output |
| 0xA    | [7..0] | [8..1] | GPIO – Output (Termination Resistor)<br>0 : Low (0 Ohm)<br>1 : High (120 Ohm)                       |

Especially, the interface of 4-port models, such as CP-114EL and CP-114EL-I, is using the following offset to set the interface of port 4.

| Offset | Bit    | Port # | Parameters                                                         |
|--------|--------|--------|--------------------------------------------------------------------|
| 0x4    | [3..0] | 1      | 0x0 : RS-232<br>0x1 : RS-422<br>0xF : RS-485 2W<br>0xB : RS-485 4W |
|        | [7..4] | 2      |                                                                    |
| 0x5    | [3..0] | 3      |                                                                    |
|        | [7..4] | -      |                                                                    |
| 0x6    | [3..0] | -      |                                                                    |
|        | [7..4] | -      |                                                                    |
| 0x7    | [3..0] | 4      |                                                                    |

## For Baud Rate Setting

For General PC Com Port: CLK=1.8432MHz

$$\text{Div} = \text{CLK}/(\text{Baud} \times 16)$$

But for Moxa Board: CLK=14.7456MHz

$$\text{Div} = \text{CLK}/(\text{Baud} \times 16)$$

## Moxa Board PCI Device ID List

| Model        | Ports | Bus         | Chip   | Max Baud | Vendor ID | Device ID |
|--------------|-------|-------------|--------|----------|-----------|-----------|
| CP-102U      | 2     | UPCI        | MU860  | 921.6k   | 0x1393    | 0x1022    |
| CP-102UL     | 2     | UPCI        | MU860  | 921.6k   | 0x1393    | 0x1021    |
| CP-132UL     | 2     | UPCI        | MU860  | 921.6k   | 0x1393    | 0x1321    |
| CP-132UL-I   | 2     | UPCI        | MU860  | 921.6k   | 0x1393    | 0x1321    |
| CP-102E      | 2     | PCIe        | MUE250 | 921.6k   | 0x1393    | 0x1024    |
| CP-102EL     | 2     | PCIe        | MUE250 | 921.6k   | 0x1393    | 0x1025    |
| CP-132EL     | 2     | PCIe        | MUE250 | 921.6k   | 0x1393    | 0x1322    |
| CP-132EL-I   | 2     | PCIe        | MUE250 | 921.6k   | 0x1393    | 0x1322    |
| CP-104UL     | 4     | UPCI        | MU860  | 921.6k   | 0x1393    | 0x1041    |
| CP-104JU     | 4     | UPCI        | MU860  | 921.6k   | 0x1393    | 0x1042    |
| CP-114UL     | 4     | UPCI        | MU860  | 921.6k   | 0x1393    | 0x1143    |
| CP-114UL-I   | 4     | UPCI        | MU860  | 921.6k   | 0x1393    | 0x1143    |
| CP-134U      | 4     | UPCI        | MU860  | 921.6k   | 0x1393    | 0x1340    |
| CP-134U-I    | 4     | UPCI        | MU860  | 921.6k   | 0x1393    | 0x1340    |
| CP-104EL-A   | 4     | PCIe        | MUE450 | 921.6k   | 0x1393    | 0x1045    |
| CP-114EL     | 4     | PCIe        | MUE450 | 921.6k   | 0x1393    | 0x1144    |
| CP-114EL-I   | 4     | PCIe        | MUE450 | 921.6k   | 0x1393    | 0x1144    |
| CP-134EL-A   | 4     | PCIe        | MUE450 | 921.6k   | 0x1393    | 0x1342    |
| CB-114       | 4     | PC/104-Plus | MU860  | 921.6k   | 0x1393    | 0x1142    |
| CB-134I      | 4     | PC/104-Plus | MU860  | 921.6k   | 0x1393    | 0x1341    |
| CP-118U      | 8     | UPCI        | MU860  | 921.6k   | 0x1393    | 0x1180    |
| CP-118U-I    | 8     | UPCI        | MU860  | 921.6k   | 0x1393    | 0x1180    |
| CP-138U      | 8     | UPCI        | MU860  | 921.6k   | 0x1393    | 0x1380    |
| CP-138U-I    | 8     | UPCI        | MU860  | 921.6k   | 0x1393    | 0x1380    |
| CP-168U      | 8     | UPCI        | MU860  | 921.6k   | 0x1393    | 0x1681    |
| CP-116E-A(A) | 8     | PCIe        | MUE850 | 921.6k   | 0x1393    | 0x1160    |
| CP-116E-A(B) | 8     | PCIe        | MUE850 | 921.6k   | 0x1393    | 0x1161    |
| CP-118EL-A   | 8     | PCIe        | MUE850 | 921.6k   | 0x1393    | 0x1182    |
| CP-118E-A-I  | 8     | PCIe        | MUE850 | 921.6k   | 0x1393    | 0x1183    |
| CP-138E-A-I  | 8     | PCIe        | MUE850 | 921.6k   | 0x1393    | 0x1381    |
| CP-168EL-A   | 8     | PCIe        | MUE850 | 921.6k   | 0x1393    | 0x1683    |
| CB-108       | 8     | PC/104-Plus | MU860  | 921.6k   | 0x1393    | 0x1080    |

## UART Datasheet

Moxa's chips are compatible with the following chips. For more details about the UART register description, please refer to the downloaded links below.

| UART    | Port | Datasheet                  |
|---------|------|----------------------------|
| MU-860  | 2-8  | <a href="#">TL16C550C</a>  |
| MUE-250 | 2    | <a href="#">PI7C9X7952</a> |
| MUE-450 | 4    | <a href="#">PI7C9X7954</a> |
| MUE-850 | 8    | <a href="#">PI7C9X7958</a> |

## Pin Assignments

The box header connector(s) on the module is used to connect to serial devices. Optional cables are available that provide DB9 or DB25 connectors. The pin assignments of the box header connectors and available cables are provided below.

### Box Header Pin Assignments

#### RS-232

These pin assignments apply to the CA-108/CB-108, CA-114/CB114, and CA-104. Note that there are two 40-pin box header connectors on the CA-108/CB108, each of which connects to 4 serial ports.

| Pin | Signal | Pin | Signal | Pin | Signal | Pin | Signal |
|-----|--------|-----|--------|-----|--------|-----|--------|
| 1   | DCD0   | 11  | DCD1   | 21  | DCD2   | 31  | DCD3   |
| 2   | DSR0   | 12  | DSR1   | 22  | DSR2   | 32  | DSR3   |
| 3   | RxD0   | 13  | RxD1   | 23  | RxD2   | 33  | RxD3   |
| 4   | RTS0   | 14  | RTS1   | 24  | RTS2   | 34  | RTS3   |
| 5   | TxD0   | 15  | TxD1   | 25  | TxD2   | 35  | TxD3   |
| 6   | CTS0   | 16  | CTS1   | 26  | CTS2   | 36  | CTS3   |
| 7   | DTR0   | 17  | DTR1   | 27  | DTR2   | 37  | DTR3   |
| 8   | -      | 18  | -      | 28  | -      | 38  | -      |
| 9   | GND0   | 19  | GND1   | 29  | GND2   | 39  | GND3   |
| 10  | -      | 20  | -      | 30  | -      | 40  | -      |

#### RS-422, 4-wire RS-485

These pin assignments apply to the CA-132, CA-132I , CA-114/CB-114, and CA-134I/CB134I. With regard to the CA Series, pins 21 to 40 apply to the CA-114 and CA-134I only.

| Pin | Signal   | Pin | Signal   | Pin* | Signal*  | Pin* | Signal*  |
|-----|----------|-----|----------|------|----------|------|----------|
| 1   | TxD0-(A) | 11  | TxD1-(A) | 21   | TxD2-(A) | 31   | TxD3-(A) |
| 3   | TxD0+(B) | 13  | TxD1+(B) | 23   | TxD2+(B) | 33   | TxD3+(B) |
| 5   | RxD0+(B) | 15  | RxD1+(B) | 25   | RxD2+(B) | 35   | RxD3+(B) |
| 7   | RxD0-(A) | 17  | RxD1-(A) | 27   | RxD2-(A) | 37   | RxD3-(A) |
| 9   | GND0     | 19  | GND1     | 29   | GND2     | 39   | GND3     |

## 2-wire RS-485

These pin assignments apply to the CA-132 , CA-132I , CA-114/CB-114, and CA-134I/CB-134I. With regard to the CA series, pins 21 to 40 apply to the CA-114 and CA-134I only.

| Pin | Signal    | Pin | Signal    | Pin* | Signal*   | Pin* | Signal*   |
|-----|-----------|-----|-----------|------|-----------|------|-----------|
| 5   | Data0+(B) | 15  | Data1+(B) | 25   | Data2+(B) | 35   | Data3+(B) |
| 7   | Data0-(A) | 17  | Data1-(A) | 27   | Data2-(A) | 37   | Data3-(A) |
| 9   | GND0      | 19  | GND1      | 29   | GND2      | 39   | GND3      |