

DA-820C Series Quick Installation Guide

x86 Rackmount Embedded Computers

Version 1.1, January 2021

Technical Support Contact Information
www.moxa.com/support

MOXA®

© 2021 Moxa Inc. All rights reserved.

P/N: 1802008201011



Overview

The DA-820C computer's main operating system is based on the Intel® Core™ i3, i5, i7 or Xeon CPU. The computer comes with 3 display ports (2 x HDMI + 1 x VGA), 5 USB ports, 4 Gigabit LAN ports, 2 3-in-1 RS-232/422/485 serial ports, 6 digital input ports and 2 digital output ports. The DA-820C is equipped with 4 hot-swappable 2.5" HDD/SSD slots and supports Intel® RST RAID 0/1/5/10 functionality. In addition, the DA-820C comes with 5 standard PCI/PCIe slots, allowing users to install various peripheral interface expansions modules.

With IEC-61850-3 and IEEE 1613 compliance, the DA-820C is sure to deliver stable and reliable system operation for power applications. The DA-820C also complies with the IEC 60255 standards, which cover the protection of electrical relays in a smart substation. IEC 60255 is one of the most widely used standards for testing relays and protection equipment, and compliance with the standard ensures that the DA-820C will work reliably and seamlessly with IEDs as part of a robust substation automation system.

Package Checklist

Each basic system model is shipped with the following standard items:

- DA-820C rackmount computer
- Rackmount kit
- Quick Installation Guide
- Documentation and software CD
- Warranty card

Hardware Installation

Front View

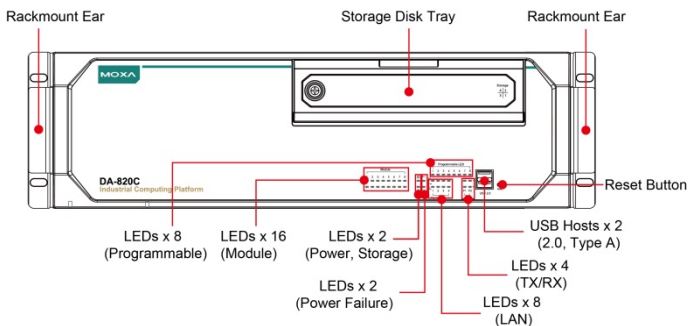

Rear View

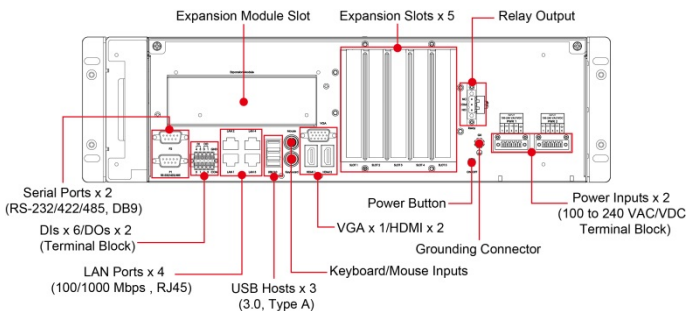

Connecting the Power

The DA-820C provides dual power inputs using a terminal block, which is located on the rear panel. Connect the power cord wires to the screws, and then tighten the screws. The **Power** LED will light up to indicate that power is being supplied to the DA-820C, after which the BIOS will initialize the flash disk module, causing the **Storage** LED to blink. It should take about 30 to 60 seconds for the operating system to complete the boot up process.

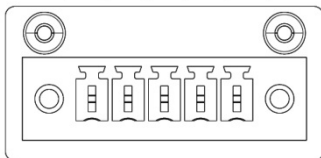
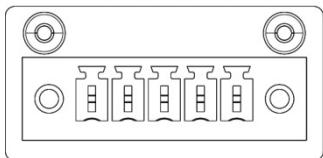
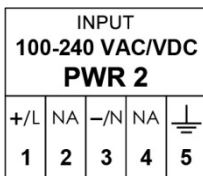
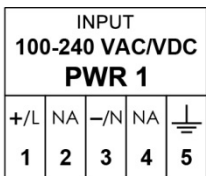

In addition, a Power button on the rear panel allows users to power on the computer when it is in the sleep or hibernate mode.

For detailed power connection and surge protection information, refer to the *DA-820C Hardware User's Manual*.

Front-panel LEDs

There are 40 LED indicators on the front panel. The LEDs are described in the following table:

LED	Color	Description
Power	Green	Power is on
	Off	No power input
Storage	Yellow/Blinking	Data is being written to or read from the storage unit
	Off	Storage unit is idle
P1	Off	The 1st power supply is on
	Red	Error in the 1st power supply
P2	Off	The 2nd power supply is on
	Red	Error in the 2nd power supply
Gigabit LAN LEDs 1 to 4	Green	100 Mbps Ethernet mode
	Orange	1000 Mbps (Gigabit) Ethernet mode
Serial Port P1/P2	Green	Tx: Serial data is being transmitted
	Yellow	Rx: Serial data is being received
Programmable LEDs 1 to 8	Green/Blinking	Can be used to indicate statuses or for debugging, as defined by users.
Module LEDs 1 to 8	Green/Orange/Blinking	Reserved for LAN-port and serial-port expansion cards.

Connecting to Displays

The DA-820C comes with 1 VGA interface that uses D-Sub 15-pin female connectors. In addition, 2 HDMI interfaces are provided on the rear panel.

NOTE For highly reliable video streaming, use premium certified HDMI cables.

Connecting to a Keyboard and Mouse

Connectors for the keyboard and a mouse are located on the rear panel of the computer. Both connectors are PS/2 interfaces; you can directly connect a keyboard and a mouse using these connectors.

USB Ports

The DA-820C comes with 2 USB 2.0 ports on the front panel and 3 USB 3.0 ports on the rear panel. The USB ports can be used to connect peripherals, such as flash drives, for expanding the system's storage capacity.

Serial Ports

The DA-820C comes with 2 software-selectable RS-232/422/485 serial ports on the rear panel. The ports use DB9 male connectors. Refer to the following table for the pin assignments:

Pin	RS-232	RS-422	RS-485 (4-wire)	RS-485 (2-wire)
1	DCD	TxDA(-)	TxDA(-)	-
2	RxD	TxDB(+)	TxDB(+)	-
3	TxD	RxDB(+)	RxDB(+)	DataB(+)
4	DTR	RxDA(-)	RxDA(-)	DataA(-)
5	GND	GND	GND	GND
6	DSR	-	-	-
7	RTS	-	-	-
8	CTS	-	-	-

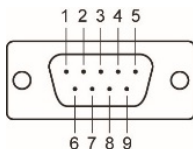

Ethernet Ports

The DA-820C has 4 100/1000 Mbps RJ45 Ethernet ports on the rear panel. Refer to the following table for pin assignments:

Pin	100 Mbps	1000 Mbps
1	Tx+	TRD(0)+
2	Tx-	TRD(0)-
3	Rx+	TRD(1)+
4	-	TRD(2)+
5	-	TRD(2)-
6	Rx-	TRD(1)-
7	-	TRD(3)+
8	-	TRD(3)-

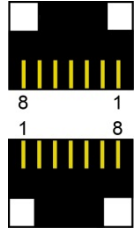

Digital Inputs/Digital Outputs

The DA-820C comes with six digital inputs and two digital outputs in a terminal block. Refer to the following figures for the pin definitions and wiring methods.

Digital Input

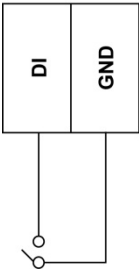

Digital Output

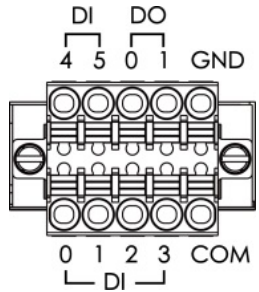
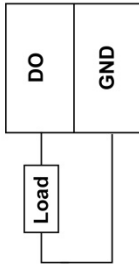

Relay Output

The DA-820C provides a relay output located on the rear panel of the computer. Refer to the figure on the right for detailed pin definition of the relay output connectors.

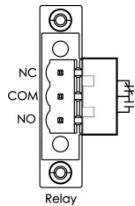

Installing Storage Disks

The DA-820C comes with four storage sockets, allowing users to install four disks for data storage. Unfasten the screw on the left side of the cover on the storage disk tray and pull down the cover. Pull out the tray to install the disks. Refer to the *DA-820C Hardware User's Manual* for details.

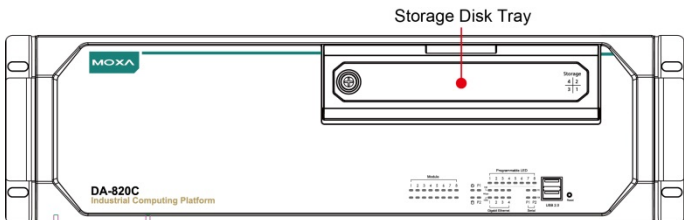

There are four slots for installing four SSD disks. The installation sequence of the disks is indicated in the diagram on the right.

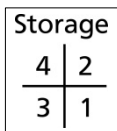

Installing Expansion Modules

The DA-820C comes with an expansion module socket on the rear panel. You can install Moxa's LAN or serial connectivity expansion module using this socket. The DA-820C also comes with five slots to install Moxa's LAN-port modules with PRP/HSR functions or fiber-port modules. Refer to the following table for the interface details of each slot.

Slot 1	Slot 2	Slot 3	Slot 4	Slot 5
PCIe x16	PCIe x4	PCIe x1	PCIe x1	PCI

For additional details, refer to the *DA-820C Hardware User's Manual*.



WARNING

Power off the computer before installing the expansion modules to avoid damage to the computer.