

AWK-3121

Quick Installation Guide

Moxa AirWorks

Sixth Edition, June 2014

MOXA®

© 2014 Moxa Inc. All rights reserved.
Reproduction without permission is prohibited.

P/N: 1802031210015

Overview

The AWK-3121 Access Point is ideal for industrial hard to wire applications, keeping wireless costs under control, and integrating with existing mobile equipment. The AWK-3121 is compliant with the industrial standards and approvals, covering operating temperature, power input voltage, surge, ESD and vibration. Installation is easy, with either DIN-Rail mounting or distribution boxes, and the DIN-Rail mounting capability, wide operating temperature range, and IP30 housing with LED indicators make the AWK-3121 a convenient yet reliable solution for any industrial wireless application.

Package Checklist

Moxa's AWK-3121 is shipped with the following items. If any of these items is missing or damaged, please contact your customer service representative for assistance.

- 1 AWK-3121
- 2 Dual-band Omnidirectional Antennas (2dBi, RP-SMA, 2.4&5GHz)
- 1 Quick Installation Guide
- 1 Software CD
- 1 Moxa Product Warranty Booklet
- 1 Cable Holder with a Screw
- 2 Protective Caps

Panel Layout of the AWK-3121

Top Panel View

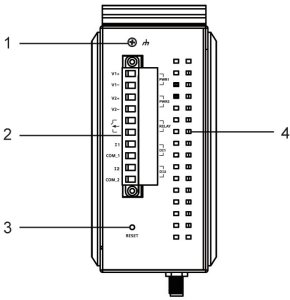

1. Grounding screw
2. Terminal block for PWR1, PWR2, relay, DI1, and DI2
3. Reset button
4. Heat dissipation orifices
5. System LEDs: PWR1, PWR2, PoE, FAULT, and STATE LEDs
6. LEDs for signal strength
7. WLAN LEDs: CLIENT, BRIDGE, and WLAN LEDs
8. RS-232 console port
9. 10/100BaseT(X) RJ45 Port
10. 10M LED
11. 100M LED
12. MAIN antenna port
13. AUX antenna port
14. Model name
15. Screw hole for wall mounting kit
16. DIN-Rail mounting kit

Front Panel View

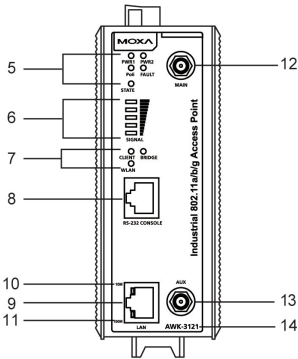

Rear Panel View

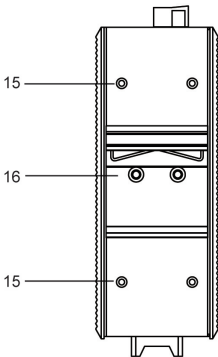

Mounting Dimensions

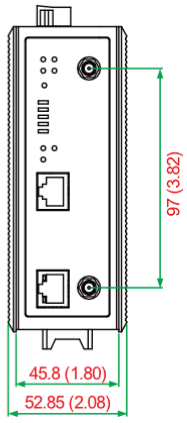
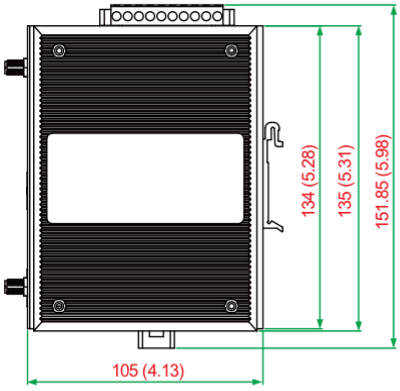
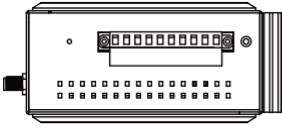

Unit = mm (inch)

DIN-Rail Mounting

The aluminum DIN-Rail attachment plate should be fixed to the back panel of the AWK-3121 when you take it out of the box. If you need to reattach the DIN-Rail attachment plate to the AWK-3121, make sure the stiff metal spring is situated towards the top, as shown in the figures below.

STEP 1:

Insert the top of the DIN-Rail into the slot just below the stiff metal spring.

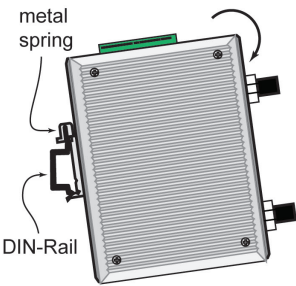

STEP 2:

The DIN-Rail attachment unit will snap into place as shown below.

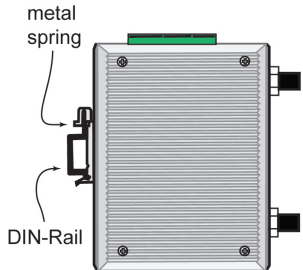

To remove the AWK-3121 from the DIN-Rail, simply reverse Steps 1 and 2.

Wall Mounting (optional)

For some applications, it may be more convenient to mount the AWK-3121 to a wall, as illustrated below.

STEP 1:

Remove the aluminum DIN-Rail attachment plate from the AWK-3121, and then attach the wall mount plates with M3 screws, as shown in the adjacent diagrams.

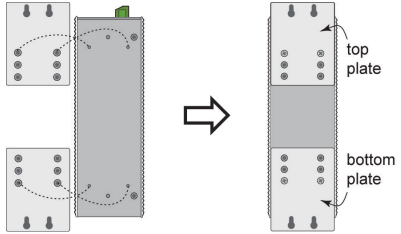

STEP 2:

Mounting the AWK-3121 to a wall requires 4 screws. Use the AWK-3121 device, with wall mount plates attached, as a guide to mark the correct locations of the 4 screws. The heads of the screws should be less than 6.0 mm in diameter, and the shafts should be less than 3.5 mm in diameter, as shown in the figure at the right.

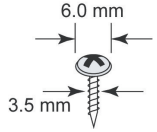

Do not screw the screws in all the way—leave a space of about 2 mm to allow room for sliding the wall mount panel between the wall and the screws.

NOTE Test the screw head and shank size by inserting the screw into one of the keyhole shaped apertures of the Wall Mounting Plates before it is screwed into the wall.

STEP 3:

Once the screws are fixed into the wall, insert the four screw heads through the large opening of the keyhole-shaped apertures, and then slide the AWK-3121 downwards, as indicated to the right. Tighten the four screws for added stability.

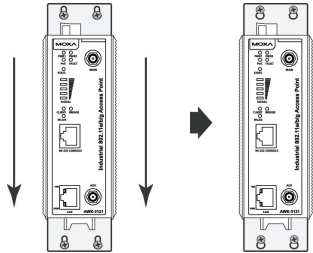

Wiring Requirements



WARNING

Safety First!

Be sure to disconnect the power cord before installing and/or wiring your Moxa AWK-3121.



WARNING

Safety First!

Calculate the maximum possible current in each power wire and common wire. Observe all electrical codes dictating the maximum current allowed for each wire size.

If the current goes above the maximum ratings, the wiring could overheat, causing serious damage to your equipment.

You should also pay attention to the following items:

- Use separate paths to route wiring for power and devices. If power wiring and device wiring paths must cross, make sure the wires are perpendicular at the intersection point.
NOTE: Do not run signal or communications wiring and power wiring in the same wire conduit. To avoid interference, wires with different signal characteristics should be routed separately.
- You can use the type of signal transmitted through a wire to determine which wires should be kept separate. The rule of thumb is that wiring with similar electrical characteristics can be bundled together.
- Keep input wiring and output wiring separate.
- It is strongly advised that you label wiring to all devices in the system when necessary.



ATTENTION

This product is intended to be supplied by a Listed Power Unit marked "Class 2" or "LPS" and rated O/P: 12 to 48 VDC, minimum 6 W (12 V/0.494 A to 48V/0.121 A), 25°C.



ATTENTION

Make sure the external power adaptor (includes power cords and plug assemblies) provided with the unit is certified and suitable for use in your country.

Grounding the Moxa AWK-3121

Grounding and wire routing help limit the effects of noise due to electromagnetic interference (EMI). Run the ground connection from the ground screw to the grounding surface prior to connecting devices.



ATTENTION

This product is intended to be mounted to a well-grounded mounting surface, such as a metal panel.

Wiring the Redundant Power Inputs

The top two pairs of contacts of the 10-contact terminal block connector on the AWK-3121's top panel are used for the AWK-3121's two DC inputs. Top and front views of the terminal block connector are shown here.

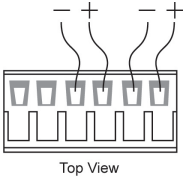

Top View

STEP 1: Insert the negative/positive DC wires into the V-/V+ terminals.

STEP 2: To keep the DC wires from pulling loose, use a small flat-blade screwdriver to tighten the wire-clamp screws on the front of the terminal block connector.

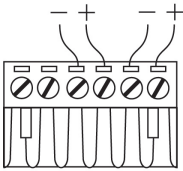

Front View

STEP 3: Insert the plastic terminal block connector prongs into the terminal block receptor, which is located on the AWK-3121's top panel.



ATTENTION

Before connecting the AWK-3121 to the DC power inputs, make sure the DC power source voltage is stable.

Wiring the Relay Contact

The AWK-3121 has one relay output, which consists of the two contacts of the terminal block on the AWK-3121's top panel. Refer to the previous section for detailed instructions on how to connect the wires to the terminal block connector, and how to attach the terminal block connector to the terminal block receptor. These relay contacts are used to indicate user-configured events. The two wires attached to the Relay contacts form an open circuit when a user-configured event is triggered. If a user-configured event does not occur, the Relay circuit will be closed.

Wiring the Digital Inputs

The AWK-3121 has two sets of digital input—DI1 and DI2. Each DI comprises two contacts of the 10-pin terminal block connector on the AWK-3121's top panel. You can refer to the "Wiring the Redundant Power Inputs" section for detailed instructions on how to connect the wires to the terminal block connector, and how to attach the terminal block connector to the terminal block receptor.

Cable Holder Installation (Optional)

You can attach the cable holder to the bottom of the AWK-3121. This helps to keep cabling neat and avoid accidents that result from untidy cables.

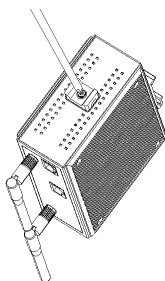

STEP 1: Screw the cable holder onto the bottom of the AWK-3121.

STEP 2: After mounting the AWK-3121 and plugging in the LAN cable, tighten the cable along the device and wall.

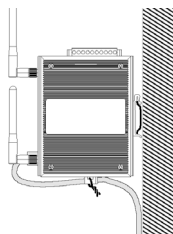
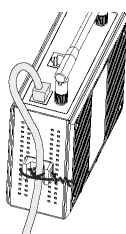
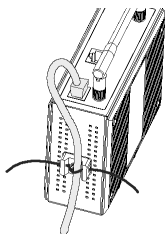

Communication Connections

10/100BaseT(X) Ethernet Port Connection

The 10/100BaseT(X) ports located on the AWK-3121's front panel are used to connect to Ethernet-enabled devices.

Below we show pinouts for both MDI (NIC-type) ports and MDI-X (HUB/Switch-type) ports.

MDI Port Pinouts		MDI-X Port Pinouts	
Pin	Signal	Pin	Signal
1	Tx+	1	Rx+
2	Tx-	2	Rx-
3	Rx+	3	Tx+
6	Rx-	6	Tx-

8-pin RJ45

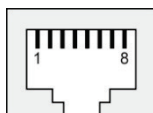

RS-232 Connection

The AWK-3121 has one RS-232 (8-pin RJ45) console port located on the front panel. Use either an RJ45-to-DB9 or RJ45-to-DB25 cable to connect the Moxa AWK-3121's console port to your PC's COM port. You may then use a console terminal program to access the AWK-3121 for console configuration.

Console Pinouts for 10-pin or 8-pin RJ45

10-Pin	Description	8-Pin
1	-----	
2	DSR	1
3	RTS	2
4	GND	3
5	TxD	4
6	RxD	5
7	DCD	6
8	CTS	7
9	DTR	8
10	-----	

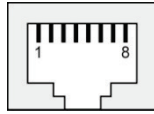

- NOTE**
1. The pin numbers for male DB9 and DB25 connectors, and hole numbers for female DB9 and DB25 connectors are labeled on the connector. However, the numbers are typically quite small, so you may need to use a magnifying glass to see the numbers clearly.
 2. The pin numbers for both 8-pin and 10-pin RJ45 connectors (and ports) are typically not labeled on the connector (or port). Refer to the Pinout diagram above to see how RJ45 pins are numbered.

ATEX Information



1. DEMKO certification number: 10 ATEX 0902666X
2. Ambient range ($-40^{\circ}\text{C} \leq T_{\text{amb}} \leq 75^{\circ}\text{C}$)
3. Certification string: Ex nA nL IIC T4
4. Standards covered (EN60079-0:2006, EN60079-15:2005)
5. The conditions of safe usage:
 - a. The Ethernet Communication Devices are intended for mounting in an IP54 enclosure and used in an area of not more than pollution degree 2 as defined by IEC60664-1.
 - b. Conductors suitable for use in an ambient temperature greater than 93°C must be used for the Power Supply Terminal.
 - c. A 4 mm² conductor must be used when connection to the external grounding screw is utilized.
 - d. Cables must be suitable for use in an ambient temperature greater than 93°C .

LED Indicators

The front panel of the Moxa AWK-3121 contains several LED indicators. The function of each LED is described in the table below.

LED	Color	State	Description
Front Panel LED Indicators (System)			
PWR1	Green	On	Power is being supplied from powerinput 1.
		Off	Power is not being supplied frompower input 1.
PWR2	Green	On	Power is being supplied from power input 2.
		Off	Power is not being supplied from power input 2.
PoE	Amber	On	Power is being supplied via PoE.
		Off	Power is not being supplied via PoE.
FAULT	Red	Blink (slow)	Cannot get an IP address from the DHCP server (interval: 1 sec)
		Blink (fast)	IP address conflict (interval: 0.5 sec)
		Off	Error condition does not exist.
STATE	Green/ Red	Green	Software Ready
		Green Blink	The AWK has been located by AWK Search Utility. (interval: 1sec)
		Red	Bootng error condition
SIGNAL (5 LEDs)	Green	On	Signal level(for Client/Slave mode only)
		Off	
BRIDGE	Green	On	WLAN function is in Bridge(WDS) Mode.
		Off	WLAN is not in Bridge(WDS) Mode.
CLIENT	Green	On	WLAN function is in Client/Slave mode and AWK has established a link with an AP.
		Blink	WLAN data communication is run in Client/Slave mode
		Off	WLAN is not in Client Mode or AWK has not established a link with an AP.
WLAN	Amber	On	WLAN functions in AP/Bridge/Master mode.
		Blink	WLAN's data communication is run in AP/Bridge/Master mode
		Off	WLAN is not in use or not working properly
TP Port LED Indicators (Port Interface)			
100M	Green	On	TP port's 100Mbps link is active .
		Blink	Data is being transmitted at 100 Mbps
		Off	TP port's 100Mbps link is inactive .
10M	Amber	On	TP port's 10Mbps link is active .
		Blink	Data is being transmitted at 10 Mbps
		Off	TP port's 10Mbps link is inactive .

Specifications

WLAN Interface	
Standards	IEEE 802.11a/b/g for Wireless LAN IEEE 802.11i for Wireless Security IEEE 802.3 for 10BaseT IEEE 802.3u for 100BaseTX IEEE 802.3af for Power-over-Ethernet IEEE 802.1D for Spanning Tree Protocol IEEE 802.1w for Rapid STP
Spread Spectrum and Modulation (typical)	DSSS with DBPSK, DQPSK, CCK OFDM with BPSK, QPSK, 16QAM, 64QAM 802.11b: <ul style="list-style-type: none"> • CCK @ 11/5.5 Mbps • DQPSK @ 2 Mbps • DBPSK @ 1 Mbps 802.11a/g: <ul style="list-style-type: none"> • 64QAM @ 54/48 Mbps • 16QAM @ 36/24 Mbps • QPSK @ 18/12 Mbps • BPSK @ 9/6 Mbps
Operating Channels (central frequency)	US: <ul style="list-style-type: none"> • 2.412 to 2.462 GHz (11 channels) • 5.18 to 5.24 GHz (4 channels) EU: <ul style="list-style-type: none"> • 2.412 to 2.472 GHz (13 channels) • 5.18 to 5.24 GHz (4 channels) JP: <ul style="list-style-type: none"> • 2.412 to 2.484 GHz (14 channels, channel 14 only support DSSS) • 5.18 to 5.24 GHz (4 channels for W52)
Security	SSID broadcast enable/disable Firewall for MAC/IP/Protocol/Port-based filtering 64-bit and 128-bit WEP encryption, WPA/WPA2-Personal and Enterprise (IEEE 802.1X/RADIUS, TKIP and AES)
Transmission Rates	802.11b: 1, 2, 5.5, 11 Mbps 802.11a/g: 6, 9, 12, 18, 24, 36, 48, 54 Mbps
TX Transmit Power	802.11b: <ul style="list-style-type: none"> • Typ. 23±1.5 dBm @ 1 to 11 Mbps 802.11g: <ul style="list-style-type: none"> • Typ. 20±1.5 dBm @ 6 to 24 Mbps • Typ. 19±1.5 dBm @ 36 Mbps • Typ. 18±1.5 dBm @ 48 Mbps • Typ. 17±1.5 dBm @ 54 Mbps 802.11a: <ul style="list-style-type: none"> • Typ. 18±1.5 dBm @ 6 to 24 Mbps • Typ. 16±1.5 dBm @ 36 to 48 Mbps • Typ. 15±1.5 dBm @ 54 Mbps
RX Sensitivity	802.11b: <ul style="list-style-type: none"> • -97 dBm @ 1 Mbps • -94 dBm @ 2 Mbps • -92 dBm @ 5.5 Mbps • -90 dBm @ 11 Mbps 802.11g:

	<ul style="list-style-type: none"> • -93 dBm @ 6 Mbps • -91 dBm @ 9 Mbps • -90 dBm @ 12 Mbps • -88 dBm @ 18 Mbps • -84 dBm @ 24 Mbps • -80 dBm @ 36 Mbps • -76 dBm @ 48 Mbps • -74 dBm @ 54 Mbps 802.11a: <ul style="list-style-type: none"> • -90 dBm @ 6 Mbps • -89 dBm @ 9 Mbps • -89 dBm @ 12 Mbps • -85 dBm @ 18 Mbps • -83 dBm @ 24 Mbps • -79 dBm @ 36 Mbps • -75 dBm @ 48 Mbps • -74 dBm @ 54 Mbps
Protocol Support	
General Protocols	Proxy ARP, DNS, HTTP, HTTPS, IP, ICMP, SNTP, TCP, UDP, RADIUS, SNMP, PPPoE, DHCP, LLDP
AP-only Protocols	ARP, BOOTP, DHCP
Interface	
Default Antennas	2 dual-band omni-directional antennas, 2 dBi, RP-SMA (male)
Connector for External Antennas	RP-SMA (female)
RJ45 Ports	1, 10/100BaseT(X) auto negotiation speed, F/H duplex mode, and auto MDI/MDI-X connection
Console Port	RS-232 (RJ45-type)
Reset	Present
LED Indicators	PWR1, PWR2, PoE, FAULT, STATE, signal strength, CLIENT MODE, BRIDGE MODE, WLAN, 10M, 100M
Alarm Contact	1 relay output with current carrying capacity of 1 A @ 24 VDC
Digital Inputs	2 electrically isolated inputs +13 to +30 V for state "1" +3 to -30 V for state "0" Max. input current: 8 mA
Physical Characteristics	
Housing	Metal, providing IP30 protection
Weight	850 g
Dimensions	54 x 135 x 105 mm (2.14 x 5.4 x 4.14 in)
Installation	DIN-Rail mounting, wall mounting (with optional kit)
Environmental Limits	
Operating Temperature	Standard Models: -25 to 60°C (-13 to 140°F) Wide Temp. Models: -40 to 75°C (-40 to 167°F)
Storage Temperature	-40 to 85°C (-40 to 185°F)
Ambient Relative Humidity	5% to 95% (non-condensing)
Power Requirements	
Input Voltage	12 to 48 VDC, redundant dual DC power inputs or 48 VDC Power-over-Ethernet (IEEE 802.3af compliant)

Connector	10-pin removable terminal block
Power Consumption	12 to 48 VDC, 0.121 to 0.494 A
Reverse Polarity Protection	Present
Standards and Certifications	
Safety	UL 60950-1, EN 60950-1
Hazardous Location	UL/cUL Class I Division 2, ATEX Zone 2
EMC	EN 301 489-1/17; FCC Part 15, Subpart B; EN 55022/55024
Radio	EN 300 328, EN 301 893, TELEC
Note: Please check Moxa's website for the most up-to-date certification status.	
Reliability	
MTBF	392,209 hrs
Warranty	
Warranty Period	5 years
Details	See www.moxa.com/support/warranty.aspx



ATTENTION

The AWK-3121 is **NOT** a portable mobile device and should be located at least 20 cm away from the human body. The AWK-3121 is **NOT** designed for the general public. To deploy AWK-3121s and establish a wireless network safely, a well-trained technician is required for installation.



ATTENTION

Use the antennas correctly: The 2.4 GHz antennas are needed when the AWK-3121 operates in IEEE 802.11b/g. The 5 GHz antennas are needed for IEEE802.11a. Make sure your antenna installation is within a safety area, which is covered by a lightning protection or surge arrest system.



ATTENTION

This device complies with part 15 of the FCC Rules. Operation is subject to the following two conditions:

1. This device may not cause harmful interference, and
2. This device must accept any interference received, including interference that may cause undesired operation.



ATTENTION

Do not locate the antenna near overhead power lines or other electric light or power circuits, or where it can come into contact with such circuits. When installing the antenna. Take extreme care not to come into contact with such circuits, because they may cause serious injury or death. For proper installation and grounding of the antenna. please refer to national and local codes (for example, U.S.:NFPA 70, National Electrical Code, Artical810, Canada: Canadian Electrical Code, Section 54).

NOTE For installation flexibility, either the MAIN antenna or the AUX antenna may be selected for use. Make sure the antenna connection matches the antenna configured in the AWK-3121 interface.

To protect the connectors and RF module, all radio ports should be terminated by either an antenna or a terminator. The use of the resistive terminator for terminating the unused antenna port is strongly recommended.



ATTENTION

For EXPLOSION-PROOF application, model AWK-3121 are designed and certified to meet ATEX, and C1D2, and shall be mounted in a suitable enclosure rate to at least IP54 and Pollution Degree 2 as defined in EN60529 and used within its rated electrical and environmental ratings.



CCAG09LP0130T2



003WWA090789
003GZA090790
003XWA090791

CMIIT ID:2009AJ5303

電波法によりW52の屋外使用は禁止されています



II 3G

DEMKO
10 ATEX 0902666X
Ex nA IIC T4 Gc
Ambient Range:
-40°C ≤ Tamb ≤ 75°C
WARNING-DO NOT
SEPARATE
WHEN ENERGIZED
Rated Cable Temp. ≥ 93°C



I.T.E. for Use in Hazardous Locations
86CY
Class I, Division 2
Groups A, B, C and D
Temp. Code T5
Max Ambient 60°C



E212360

Fl.4, No.135, Lane 235, Baoqiao Rd. Xindian Dist., New Taipei City, Taiwan, R.O.C

Technical Support Contact Information www.moxa.com/support

Moxa Americas:

Toll-free: 1-888-669-2872
Tel: 1-714-528-6777
Fax: 1-714-528-6778

Moxa China (Shanghai office):

Toll-free: 800-820-5036
Tel: +86-21-5258-9955
Fax: +86-21-5258-5505

Moxa Europe:

Tel: +49-89-3 70 03 99-0
Fax: +49-89-3 70 03 99-99

Moxa Asia-Pacific:

Tel: +886-2-8919-1230
Fax: +886-2-8919-1231