

# OnCell 3120-LTE-1 Series Quick Installation Guide

---

Moxa OnCell Series

Version 1.1, January 2021

Technical Support Contact Information  
[www.moxa.com/support](http://www.moxa.com/support)

**MOXA**®

© 2021 Moxa Inc. All rights reserved.

**P/N: 1802031200011**



## Overview

The OnCell 3120-LTE-1 is a reliable, secure, LTE gateway with a state-of-the-art global LTE module. This 4G cellular gateway provides a more reliable connection to your Ethernet network for cellular applications.

The OnCell 3120-LTE-1 is ideal for remote-access applications where power consumption needs to be well managed. The power-saving functions, which include power scheduling, allow you to manage the power consumption in your cellular network. Wide-temperature support coupled with high-level EMS protection give the OnCell 3120-LTE-1 the highest level of device stability for any rugged environment. In addition, dual-SIM and GuaranLink support help provide network redundancy to ensure uninterrupted connectivity.

The OnCell 3120-LTE-1 also comes with a 3-in-1 serial port for serial-over-LTE cellular network communication, making it suitable for collecting and exchanging data with serial/Ethernet devices.

## Package Checklist

Before installing your OnCell 3120-LTE-1, verify that the package contains the following items. If any of these items is missing or damaged, please contact your customer service representative for assistance.

- 1 OnCell 3120-LTE-1 unit
- 1 DIN-rail mounting kit
- 1 console cable
- Quick installation guide (printed)
- Warranty card

## Installation and Configuration

You will need access to a notebook computer or PC equipped with an Ethernet port. The OnCell 3120-LTE-1 has a default IP address that you must use when connecting to the device for the first time.

Take the following steps to configure your OnCell 3120-LTE-1. Refer to the [Panel Layout of the OnCell 3120-LTE-1](#) section below for the location of the ports and sockets.

### **Step 1: Insert a SIM card and turn on the OnCell 3120-LTE-1**

1. Use a screwdriver to loosen the screws and remove the SIM card cover located on the top panel of the OnCell 3120-LTE-1.
2. Insert one or two 4G SIM cards (nano SIM) into the SIM card slot(s). If you are only using one SIM card, insert it in the top slot (slot 1; the card in slot 1 is referred to as SIM1).  
By default, the SIM card in slot 1 is treated as the primary card. To change the default to SIM2 (the card in slot 2), log in to the OnCell's web UI, and configure SIM2 as the primary card. When the OnCell device is turned on, it boots up based on the configuration information stored on the primary SIM card.
3. Turn on the OnCell 3120-LTE-1 by connecting a power terminal block to a DC power source (9 to 36 VDC). For details, refer to the [Connecting the Power Input](#) section.
4. Reattach the cover.

### **Step 2: Connect the OnCell 3120-LTE-1 to a notebook or PC**

Since the OnCell 3120-LTE-1 supports MDI/MDI-X auto-sensing, you can use either a straight-through cable or crossover cable to connect the OnCell 3120-LTE-1 to a computer. See the [10/100BaseT\(X\) Ethernet Port Connection](#) section below for detailed instructions. If the LAN LED indicator on the OnCell 3120-LTE-1 lights up, it means a connection has been established.

### **Step 3: Set up an IP address for the computer**

Set an IP address on the same subnet as the OnCell 3120-LTE-1. Since the OnCell 3120-LTE-1's default IP address is **192.168.127.254**, and the subnet mask is **255.255.255.0**, you should set the IP address of the computer to 192.168.127.xxx and the subnet mask to 255.255.255.0.

### **Step 4: Use the web-based manager to configure the OnCell 3120-LTE-1**

Open your computer's web browser and type **http://192.168.127.254** in the address field to access the homepage of the web-based management system. Before the homepage opens, you will need to enter the username and password. For first-time configuration, enter the default username and password given below:

Username: **admin**

Password: **moxa**

Click on the **Login** button.



#### **ATTENTION**

For security reasons, we strongly recommend changing the password. To change the password, select **Maintenance** → **Username/Password**, and then follow the on-screen instructions.

**NOTE** You must click the **Save Configuration** and then the **Restart** buttons for the configuration changes to take effect.

# Panel Layout of the OnCell 3120-LTE-1

Top Panel View

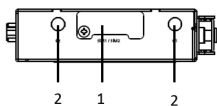

1. SIM card holders (SIM1/SIM2)
2. 2x2 MIMO cellular antenna port
3. 10/100 Base-T(X) Ethernet port 1 (RJ45)
4. 10/100 Base-T(X) Ethernet port 2 (RJ45)
5. USB port
6. DB9 serial port
7. LED display
8. Reset button
9. Console port (reserved for engineering use)
10. Grounding screw (M3)
11. Terminal block (V+, V-, GND)
12. LED display
13. DIN-rail mounting kit

Front Panel View

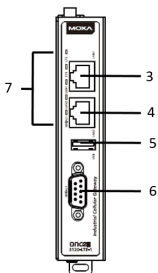

Bottom Panel View

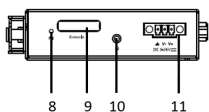

Side Panel View

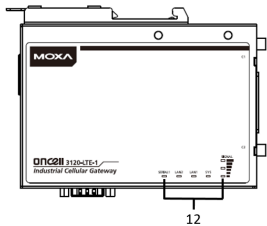

Back Panel View

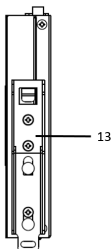

## Device Dimensions

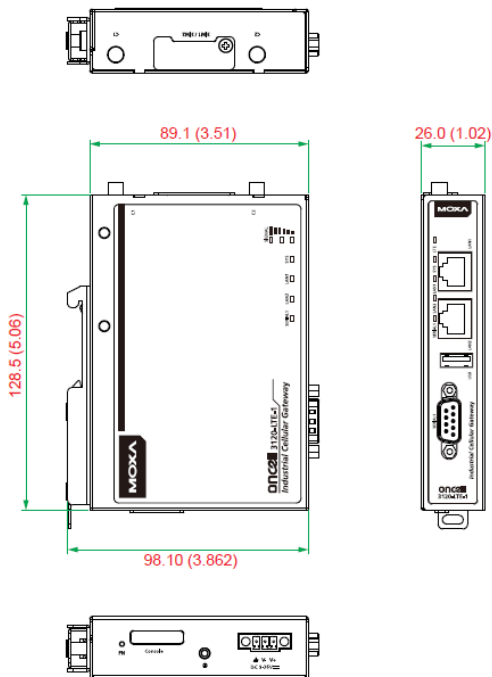

## DIN-rail Mounting

The OnCell 3120-LTE-1 Series comes with a DIN-rail kit attached to the back panel. Mount the OnCell 3120-LTE-1 Series on corrosion-free mounting rails that meet the EN 60715 standard.

## Installation

**STEP 1:** Insert the upper lip of the DIN rail into the top hook of the DIN-rail mounting kit.

**STEP 2:** Press the OnCell 3120-LTE-1 Series towards the DIN rail until it snaps into place.

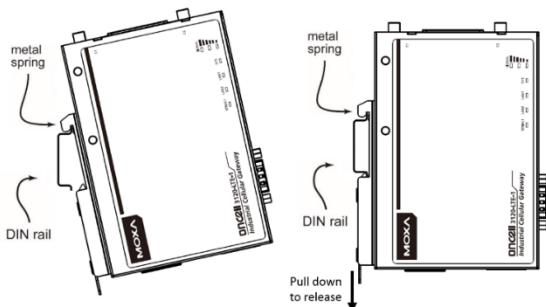

To remove the OnCell 3120-LTE-1 from the DIN rail, pull down the lever at the bottom of the DIN-rail kit.

## Wall Mounting (optional)

For some applications, it may be more convenient to mount the OnCell 3120-LTE-1 to a wall, as illustrated below:

### STEP 1:

Remove the aluminum DIN-rail attachment plate from the OnCell 3120-LTE-1, and then attach the wall-mounting plates with M3 screws, as shown in the adjacent diagram.

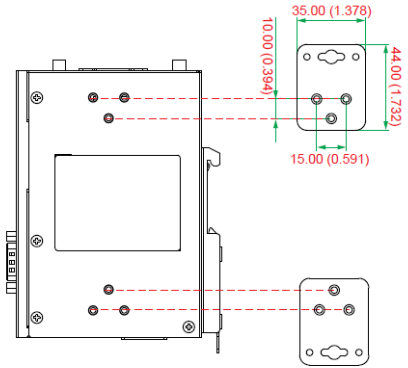

### STEP 2:

Mounting the OnCell 3120-LTE-1 to a wall requires 4 screws. Use the OnCell 3120-LTE-1 device, with wall mount plates attached as a guide, to mark the correct locations of the 4 screws. The heads of the screws should be less than 6.0 mm in diameter, and the shafts should be less than 3.5 mm in diameter, as shown in the figure at the right.

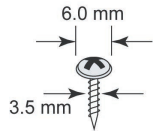

**NOTE** Test the screw head and shank size by inserting the screws into one of the keyhole shaped apertures of the wall-mounting plates before attaching the plates to the wall.

### STEP 3:

Once the screws are fixed into the wall, insert the four screw heads through the large opening of the keyhole-shaped apertures of the mounting kit, and then slide the OnCell 3120-LTE-1 downwards. Tighten the four screws for added stability.

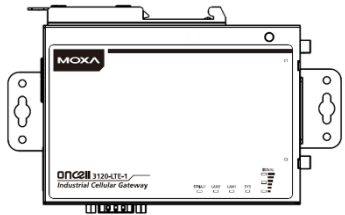



## WARNING

- This equipment is intended to be used in a Restricted Access Location, such as a dedicated computer room, where access can only be gained by SERVICE PERSONS or by USERS who have been instructed about the fact that the metal chassis of the equipment is extremely hot and may cause burns.
- Service persons or users should pay special attention and take special precautions before handling this equipment.
- Only authorized, well-trained professionals should be allowed to access the restricted access location. Access should be controlled by the authority responsible for the location with lock and key or a security identity system.
- **External Metal Parts are Hot!!** Pay special attention or use special protection before handling this equipment.

## Wiring Requirements



## WARNING

### Safety First!

Be sure to disconnect the power cord before installing and/or wiring the OnCell 3120-LTE-1 device.

## Read and Follow These Guidelines

- Use separate paths to route wiring for power and devices. If power wiring and device wiring paths must cross, make sure the wires are perpendicular at the intersection point.

**NOTE** Do not run signal or communications wiring and power wiring in the same wire conduit. To avoid interference, wires with different signal characteristics should be routed separately.

- You can use the type of signal transmitted through a wire to determine which wires should be kept separate. The rule of thumb is that wiring with similar electrical characteristics can be bundled together.
- Keep input wiring and output wiring separate.
- It is strongly advised that you label wiring to all devices in the system when necessary.



## ATTENTION

This product is intended to be supplied by a Listed Power Unit marked "Class 2" or "LPS" and rated O/P: 9.6 W (12 V/0.78 A to 48 V/0.2 A).

## Grounding the Moxa OnCell 3120-LTE-1

Grounding and wire routing help limit the effects of noise due to electromagnetic interference (EMI). Run the ground connection from the ground screw to the grounding surface prior to connecting devices. The minimum cross-sectional area of the grounding conductor should be equal to that of the input cable.



### ATTENTION

This product is intended to be mounted on a well-grounded mounting surface, such as a metal panel. The potential difference between the two ground potentials must be zero. If the potential difference is NOT zero, the product could be permanently damaged.

## SIM Card Socket

The OnCell 3120-LTE-1 comes with two nano-SIM card sockets for cellular communication. The nano-SIM card sockets are located on the top panel along with the antenna connectors. Loosen the screws and then remove the cover to access the SIM-card sockets, and then insert the nano-SIM cards into the sockets directly. You will hear a click when the cards are in place. The left socket is for SIM 1 and the right socket is for SIM 2. To remove the cards, push the cards in before releasing them.



SIM Card Socket

## Connecting the Power Input

### Pinouts for the Power Inputs

Pin	Name	Usage
1	V1+	DC Power Input 1
2	V1-	DC Power Input 2
3	GND	Ground



↔ V- V+  
DC 9-36V



## Wiring the Power Input

Top and front views of the terminal block connector are shown below:

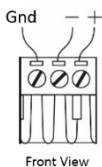
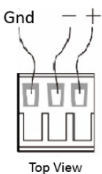

**STEP 1:** Insert the negative/positive DC wires into the V-/V+ terminals, and the ground wire into the GND terminal.

**STEP 2:** To keep the DC wires from pulling loose, use a small flat-blade screwdriver to tighten the wire-clamp screws on the front of the terminal block connector.

**STEP 3:** Insert the plastic terminal block connector prongs into the terminal block receptor, which is located on the bottom panel of the OnCell 3120-LTE-1.



### ATTENTION

Before connecting the OnCell 3120-LTE-1 to the DC power inputs, make sure that the DC power source voltage is stable.

## Communication Connections

### 10/100Base-T(X) Ethernet Port Connection

The 10/100Base-T(X) ports located on the front panel of the OnCell 3120-LTE-1 are used to connect to Ethernet-enabled devices.

Pinouts for both MDI (NIC-type) ports and MDI-X (HUB/Switch-type) ports are shown below:

MDI Port Pinouts		MDI-X Port Pinouts		8-pin RJ45
Pin	Signal	Pin	Signal	
1	Tx+	1	Rx+	
2	Tx-	2	Rx-	
3	Rx+	3	Tx+	
6	Rx-	6	Tx-	

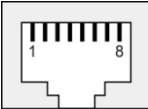

### Serial DB9 Connection

The OnCell 3120-LTE-1 has one DB9 male port that supports RS-232, RS-485-4W, RS-485-2W, and RS-422. The pin assignments are shown in the table below:

## DB9 Male Connector

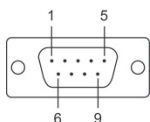

Pin	RS-232	RS-422/485-4w	RS-485-2w
1	DCD	TxD-(A)	-
2	RxD	TxD+(B)	-
3	TxD	RxD+(B)	Data+(B)
4	DTR	RxD-(A)	Data-(A)
5	GND	GND	GND
6	DSR	-	-
7	TRS	-	-
8	CTS	-	-
9	-	-	-

## Console Port

The console port is an RS-232 port that you can connect to with a 4-pin pin header cable (in the package). You can use this port for debugging or firmware upgrades.

Pin	Signal
1	GND
2	NC
3	RxD
4	TxD

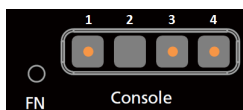

## USB

The OnCell 3120-LTE-1 is provided with a type-A USB 2.0 port, which can be used to connect USB storage device or other type-A USB compatible devices.

## LED Indicators

LED indicators are provided on the side panel of the OnCell 3120-LTE-1. The function of each LED is described in the table below:

LED	Color	Behavior	Function
SYS (2 LEDs)	Green		Power On: System startup is complete and the system is in operation.
	Off		No power is supplied to the OnCell device.
	Green	1. Blinking at 1-sec intervals	1. The OnCell device has been located by the Wireless Search Utility.
		2. Blinking at 2-sec intervals	2. The ABC-02-USB device connected to OnCell device has been detected.
Red	3. Blinking at 0.5-sec intervals	3. Importing or exporting files from/to the ABC-02-USB device.	
	4. Blinking at 5-sec intervals	4. The OnCell device is in power saving mode.	
LAN 1/2	Green	1. Steady On	1. System error or failure to get an IP address for the device.
		2. Blinking at 1-sec intervals	2. Load/save to the ABC-02-USB device failed.
LAN 1/2	Green		10/100 Mbps Ethernet mode.

LED	Color	Behavior	Function		
(4 LEDs)	Off		Not active.		
Serial (2 LEDs)	Green		Transmitting or receiving data.		
	Off		Not active.		
LTE (1 LED)	Green		LTE is connected.		
	Green	Blinking at 0.5-sec intervals	UMTS/HSPA/GSM/GPRS/EDGE is connected.		
	Off		No cellular connection.		
Signal (3 LEDs)	Green	<b>Signal Strength*</b>	<b>Cellular RSSI</b>	<b>RSSI Range (dBm)</b>	<b>Comment</b>
		1-2	$0 < \text{SNR} \leq 12$	$113 < \text{RSSI} \leq -89$	Marginal
		3-4	$12 < \text{SNR} \leq 21$	$-89 < \text{RSSI} \leq -73$	Good
		5-6	$22 < \text{SNR} \leq 31$	$-73 < \text{RSSI} \leq -51$	Excellent

\*Each signal LED is equivalent to a signal strength of 2 levels.

**NOTE** The LTE LED is designated for the cellular connectivity standard and the SIGNAL LED indicates the cellular signal strength.

## Specifications

Input Current	0.8 A (max.)
Input Voltage	9 to 36 VDC
Power Consumption	5 W (typ.)
Operating Temperature	Standard Models: 0 to 55°C (32 to 131°F) Wide Temp. Models: -30 to 70°C (-22 to 158°F)
Storage Temperature	-40 to 85°C (-40 to 185°F)



### ATTENTION

The OnCell 3120-LTE-1 is **NOT** a portable mobile device and should be located at least 20 cm away from the human body.

The OnCell 3120-LTE-1 is **NOT** designed for the general public. A well-trained technician is required to deploy the OnCell 3120-LTE-1 units and safely establish a wireless network.



### ATTENTION

#### Use the antennas correctly!

Wide-band (2G/3G/4G) antennas are needed when the OnCell 3120-LTE-1 operates. Make sure that your antenna installation is within a safety area, which is covered by a **lightning protection or surge arrest** system.



## **ATTENTION**

This device complies with part 15 of the FCC Rules. Operation is subject to the following two conditions:

1. This device may not cause harmful interference.
2. This device must accept any interference received, including interference that may cause undesired operation.



## **ATTENTION**

Do not locate the antenna near overhead power lines or other electric light or power circuits, or where it can come into contact with such circuits. When installing the antenna, take extreme care not to come into contact with such circuits, because they may cause serious injury or death when there is a surge. For instructions on proper installation and grounding of the antenna, refer to national and local codes (for example, U.S.: NFPA 70, National Electrical Code, Article 810, and Canada: Canadian Electrical Code, Section 54).



## **ATTENTION**

For EXPLOSION-PROOF applications, the OnCell 3120-LTE-1 is designed and certified to meet ATEX and IECEx requirements. You should mount the device in a suitable enclosure rated at least IP54, in accordance with IEC/EN 60079-15 standard, so that it is accessible only by the use of a tool. The device is not intended for use in an area with pollution degree rating > 2 in accordance with EN 60664-1.

When you install the OnCell 3120-LTE-1 in an enclosure, the antennas must also be installed in such a way that they are inside the enclosure. External antenna deployment is allowed only if the antennas are certified for ATEX Zone 2 use or conform to the IECEx standards.



## **WARNING**

### **EXPLOSION HAZARD!**

Do not disconnect equipment unless you have removed the power source to the equipment or the area is known to be non-hazardous.

## ATEX / IECEx Zone 2 Certification Information



1. ATEX Certificate Number: DEMKO 18 ATEX 2120X  
IECEx Certificate Number: IECEx UL 18.0113X
2. Ambient Range:  $-30^{\circ}\text{C} \leq T_a \leq +70^{\circ}\text{C}$ , or  $-30^{\circ}\text{C} \leq T_{amb} \leq +70^{\circ}\text{C}$
3. Certification String : Ex nA IIC T4 Gc  
Rated Cable Temp  $\geq 90^{\circ}\text{C}$
4. Standards Covered:  
EN 60079-0:2012+A11:2013  
EN 60079-15:2010  
IEC 60079-0, 6<sup>th</sup> Edition (2011-06) + Corr. 1 (2012-01) + Corr. 2 (2013-12) + I-SH 01 (2013-11) + I-SH 02 (2014-10), IEC 60079-15, 4<sup>th</sup> Edition (2010-01) + I-SH 01 (2016-09)
5. Conditions for Safe Usage:  
These devices shall be mounted in a suitable tool-accessible ATEX/IECEx certified enclosure rated at least IP54 as defined in EN/IEC 60529, Pollution Degree 2 and EN/IEC 60664-1, and shall be used within their rated electrical and environmental ratings.

### Grounding-wire Size

The minimum cross-sectional area of the grounding conductor should be equal to that of the input cable.

**Moxa Inc.**

No. 1111, Heping Rd., Bade Dist., Taoyuan City 334004, Taiwan