

# NE-4100 Series Serial Command Mode User Manual

---

Version 2.1, July 2022

[www.moxa.com/products](http://www.moxa.com/products)

**MOXA**<sup>®</sup>

© 2022 Moxa Inc. All rights reserved.

# NE-4100 Series Serial Command Mode User Manual

The software described in this manual is furnished under a license agreement and may be used only in accordance with the terms of that agreement.

## Copyright Notice

© 2022 Moxa Inc. All rights reserved.

## Trademarks

The MOXA logo is a registered trademark of Moxa Inc.  
All other trademarks or registered marks in this manual belong to their respective manufacturers.

## Disclaimer

- Information in this document is subject to change without notice and does not represent a commitment on the part of Moxa.
- Moxa provides this document as is, without warranty of any kind, either expressed or implied, including, but not limited to, its particular purpose. Moxa reserves the right to make improvements and/or changes to this manual, or to the products and/or the programs described in this manual, at any time.
- Information provided in this manual is intended to be accurate and reliable. However, Moxa assumes no responsibility for its use, or for any infringements on the rights of third parties that may result from its use.
- This product might include unintentional technical or typographical errors. Changes are periodically made to the information herein to correct such errors, and these changes are incorporated into new editions of the publication.

## Technical Support Contact Information

[www.moxa.com/support](http://www.moxa.com/support)

# Table of Contents

<b>1. Introduction .....</b>	<b>4</b>
<b>2. Serial Command Format and Command Set .....</b>	<b>5</b>
<b>3. Operation Flow Chart.....</b>	<b>9</b>
<b>4. Configuring Serial Command Mode by Entering Trigger Type .....</b>	<b>10</b>
Network Enabler Administrator .....	10
Telnet Console .....	12
Web Console .....	13
Serial Console .....	14
<b>5. Entering Serial Command Mode .....</b>	<b>15</b>
Trigger Type .....	15
Serial Port Parameters.....	15
Comments .....	16
<b>6. Exiting Serial Command Mode .....</b>	<b>17</b>
<b>7. Determining the Active Mode.....</b>	<b>18</b>
By Network Enabler Administrator .....	18
By Text via the Serial Port .....	19
<b>8. SW Reset Function.....</b>	<b>20</b>
<b>9. Factory Defaults .....</b>	<b>21</b>
Serial Port Defaults .....	21
Ethernet Port Defaults .....	21
Default Operation Mode.....	21
Default Trigger Method.....	21
<b>10. Demonstration/Testing Environment .....</b>	<b>22</b>
Example 1: Get Model Name using HW Trigger .....	22
Example 2: Change IP Address using HW Trigger.....	23
Example 3: Get IP Mode using SW Trigger .....	23
Example 4: Change TCP Port Number using SW Trigger.....	24

# 1. Introduction

---

The Serial Command Mode function described in this User Manual is built into the firmware of the Command Mode models of Moxa's NE-4100 Series of Embedded Network Enablers. All five models, which are listed below, support auto-detecting 10/100 Mbps Ethernet.

- NE-4100T-CMD: Serial (TTL) to Ethernet—Drop-in type
- NE-4110S-CMD: Serial (RS-232) to Ethernet—RJ45 type
- NE-4110A-CMD: Serial (RS-422/485) to Ethernet—RJ45 type
- NE-4120S-CMD: Serial (RS-232) to Ethernet—Pin-header type
- NE-4120A-CMD: Serial (RS-422/485) to Ethernet—Pin-header type

Serial Command Mode serial commands are used to retrieve or configure parameters stored in NE-4100 Series products' flash memory. Since the commands are sent via the module's serial port (P0), Serial Command Mode gives serial device manufacturers the option to add local configuration capability to their products. For example, card reader manufacturers can use the card reader's number pad to configure network settings (IP address, netmask, etc.) and serial settings (baud rate, data bits, etc.), allowing end-users to configure the device on-site, without the need to carry around and set up a notebook computer.

# 2. Serial Command Format and Command Set

In this chapter, we describe the structure of the data frames used to issue commands and receive replies to and from the device. The basic Command Frame Format and Reply Frame Format are:

### Command Frame Format

Descriptor	C-Head (>)	Command Code	OP Code	Parameter	Tail (CR)
Length (bytes)	1	1	2	Variable	1

### Reply Frame Format

Descriptor	R-Head (<)	Reply Code	OP Code	Parameter	Tail (CR)
Length (bytes)	1	1	2	Variable	1

The possible settings of each descriptor are given below. All Command Code, OP Code, and Return Code values must be in upper case. Note that "OP Code" and "Parameter" are described together, since they come as a pair. That is, the length and meaning of the Parameter descriptor depends on which OP Code value is used.

#### C-Head

Settings	Comments
>	Fixed value (HEX = 3Eh)

#### R-Head

Settings	Comments
<	Fixed value (HEX = 3Ch)

#### Tail

Settings	Comments
CR	Fixed value (HEX = 0Dh)

#### Command Code

Settings	Comments
R	Get Network Enabler parameter
W	Set Network Enabler parameter

#### Reply Code

Settings	Comments
Y	Command was executed successfully
1	Command not supported
2	OP code not supported
3	Invalid command encapsulation
4	Invalid parameter
5	Invalid return value
E	Enter serial command mode

**OP Code / Parameter**

OP Code Settings	Parameter	Device setting
<b>Basic Commands</b>		
BS	<i>read only</i>	Serial Number
BV	<i>read only</i>	Firmware Version
BN	<i>alphanumeric</i> (Max. 15 bytes)	Device Name
BW	0: Disable 1: Enable	Web Console
BT	0: Disable 1: Enable	Telnet Console
BP	<i>alphanumeric</i> (Max. 10 bytes)	Password
BR	1: Restart only 2: Save & Restart (Write Only)	Save and Restart
NC	0: Static 1: DHCP	IP Configuration Method
NP	xxx.xxx.xxx.xxx (e.g., 192.168.127.254)	IP Address
NM	xxx.xxx.xxx.xxx (e.g., 255.255.0.0)	Netmask Address
NG	xxx.xxx.xxx.xxx (e.g., 192.168.1.254)	Gateway Address
NA	<i>read only</i> (e.g., 00:90:e8:09:44:fe)	MAC Address
<b>Accessible IP</b>		
AS	0: Disable 1: Enable	Enable IP Filter
AA   AP	xxx.xxx.xxx.xxx   xxx.xxx.xxx.xxx (e.g., 192.168.127.1)	Accessible IP Address 01   Accessible IP Address 16
Aa   Ap	xxx.xxx.xxx.xxx   xxx.xxx.xxx.xxx (e.g., 255.255.255.0)	Accessible Netmask 01   Accessible Netmask 16
<b>Operation Mode</b>		
OM	0: Real COM 1: TCP server 2: TCP client 3: UDP mode	Operation Mode
<b>TCP Server Mode</b>		
TM	1 - 4	Max. number of connections
TL	0 - 65535	Local List Port
TT	0 - 99 (minutes)	TCP Alive Check Timeout
TI	0 - 65535 (ms)	Inactivity Timeout
TX	0: Disable 1: Enable 1-character 2: Enable 2 characters	Number of delimiters
TY	<i>ascii character</i> (e.g., "a1")	Delimiter 1
TZ	<i>ascii character</i> (e.g., "a1")	Delimiter 2
TF	0 - 65535 (ms)	Force Tx Timeout

OP Code Settings	Parameter	Device setting
<b>Real COM Mode</b>		
RM	1 – 4	Max. number of connections
RT	0 – 99 (minutes)	TCP Alive Check Timeout
RX	0: Disable 1: Enable 1-character 2: Enable 2 characters	Number of delimiters
RY	<i>ascii character</i> (e.g., "a1")	Delimiter 1
RZ	<i>ascii character</i> (e.g., "a1")	Delimiter 2
RF	0 – 65535 (ms)	Force Tx Timeout
<b>TCP Client Mode</b>		
CM	0: Startup 1: Any character	Connect Mode
CA	<i>xxx.xxx.xxx.xxx</i> (e.g., 192.168.1.1)	Destination Host IP 1
CB	<i>xxx.xxx.xxx.xxx</i> (e.g., 192.168.1.1)	Destination Host IP 2
CC	<i>xxx.xxx.xxx.xxx</i> (e.g., 192.168.1.1)	Destination Host IP 3
CD	<i>xxx.xxx.xxx.xxx</i> (e.g., 192.168.1.1)	Destination Host IP 4
C1	0 – 65535	Client Port 1
C2	0 – 65535	Client Port 2
C3	0 – 65535	Client Port 3
C4	0 – 65535	Client Port 4
CT	0 – 99 (minutes)	TCP Alive Check Timeout
CI	0 – 65535 (ms)	Inactivity Timeout
CX	0: Disable 1: Enable 1-character 2: Enable 2 characters	Number of delimiters
CY	<i>ascii character</i> (e.g., "a1")	Delimiter 1
CZ	<i>ascii character</i> (e.g., "a1")	Delimiter 2
CF	0 – 65535 (ms)	Force Tx Timeout
<b>UDP Mode</b>		
UL	0 – 65535	Local Listen Port
UA	<i>xxx.xxx.xxx.xxx</i> (e.g., 192.168.1.1)	First IP of range 1
UB	<i>xxx.xxx.xxx.xxx</i> (e.g., 192.168.1.1)	First IP of range 2
UC	<i>xxx.xxx.xxx.xxx</i> (e.g., 192.168.1.1)	First IP of range 3
UD	<i>xxx.xxx.xxx.xxx</i> (e.g., 192.168.1.1)	First IP of range 4
Ua	<i>xxx.xxx.xxx.xxx</i> (e.g., 192.168.1.1)	Last IP of range 1
Ub	<i>xxx.xxx.xxx.xxx</i> (e.g., 192.168.1.1)	Last IP of range 2
Uc	<i>xxx.xxx.xxx.xxx</i> (e.g., 192.168.1.1)	Last IP of range 3
Ud	<i>xxx.xxx.xxx.xxx</i> (e.g., 192.168.1.1)	Last IP of range 4
U1	0 – 65535	UDP Port 1
U2	0 – 65535	UDP Port 2
U3	0 – 65535	UDP Port 3
U4	0 – 65535	UDP Port 4

OP Code Settings	Parameter	Device setting
UX	0: Disable 1: Enable 1-character 2: Enable 2 characters	Number of delimiters
UY	<i>ascii character</i> (e.g., "a1")	Delimiter 1
UZ	<i>ascii character</i> (e.g., "a1")	Delimiter 2
UF	0 – 65535 (ms)	Force Tx Timeout
<b>Digital IO</b>		
DM	<u>bytes 1 and 2 (DIO #)</u> 00: DIO_0 01: DIO_1 02: DIO_2 03: DIO_3  <u>byte 3 (DIO Mode)</u> 0: input 1: output	DIO Mode  (e.g., "000" sets DIO_0 to input mode)
DS	<u>bytes 1 and 2 (DIO #)</u> 00: DIO_0 01: DIO_1 02: DIO_2 03: DIO_3  <u>byte 3 (DIO Status)</u> 0: low 1: high	DIO Status  (e.g., "011" sets DIO_1 to high)
<b>Serial Command Mode</b>		
ES	0: Disable 1: Enable HW Trigger 2: Enable SW Trigger	Enable Serial Command Mode
EC	<i>3 4-byte characters</i>	Enter Command Mode Characters (in HEX format; e.g., 2A EE 5F)



# 3. Operation Flow Chart

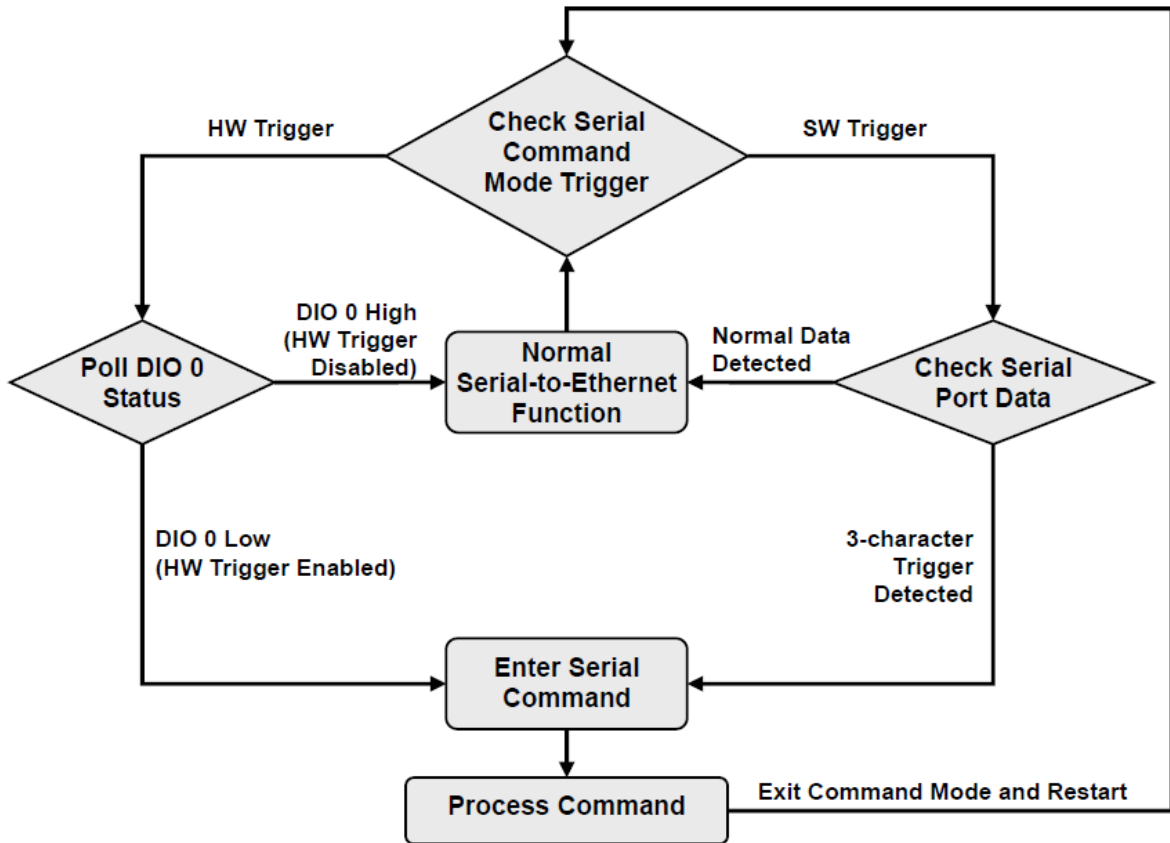

## NOTE

1. This flowchart represents a continual process. You can start trace out a logical flow by starting anywhere on the chart.
2. Diamonds represent decision points. Only one path leading out of any diamond can be followed.

# 4. Configuring Serial Command Mode by Entering Trigger Type

In this chapter, we explain how to configure the type of trigger (hardware or software) that will activate Serial Command Mode. The trigger type can be configured over the network with Network Enabler Administrator, Telnet Console, or Web Console, or through the serial console port by Serial Console.

## Network Enabler Administrator

Network Enabler Administrator 2.6 provides a convenient way to configure NE-4100-CMD.

1. After installing **Network Enabler Administrator 2.6**, double click on the shortcut icon on your Windows desktop to start the program.



2. Use **Broadcast Search** or **Search by IP** to locate the NE-4100-CMD you wish to configure. Keep in mind that Broadcast Search will locate all Network Enabler products connected to the same LAN as your PC. Search by IP can be used to locate Network Enablers that are NOT connected to the LAN. However, if you use Search by IP to locate a Network Enabler connected to the same LAN as your PC, the Network Enabler and PC must be on the same subnet.

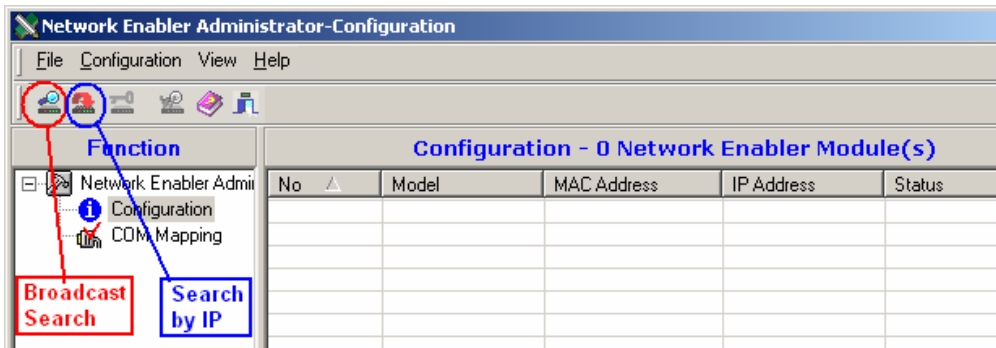

3. Once the NE-4100-CMD is located, click on the product's **Model** to highlight it, and then click the right mouse button. Select the **Configuration** option.

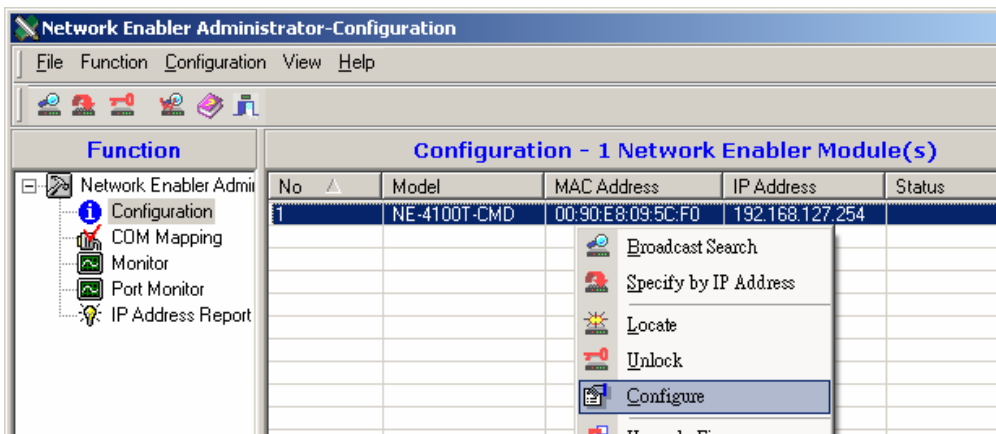

4. Check the **Modify** box to change the configuration. If the **Enable** box is not checked, then Serial Command Mode is disabled. There are two **Enable** options:

#### HW Trigger

The screenshot shows the 'Configuration' page for the NE-4100T-CMD device. The left sidebar lists device information: Model (NE-4100T-CMD), MAC Address (00:90:E8:09:5C:F0), Serial Number (44), Firmware Ver. (Ver 3.2), and BIOS Ver. (Ver 1.1). The main content area has tabs for Basic, Network, Serial, Operating Mode, and Accessible IPs. Under the 'Serial' tab, there are sub-tabs for Auto Warning, IP Address Report, Password, Digital IO, and Serial CMD. The 'Serial CMD' sub-tab is active. It contains a 'Modify' checkbox (checked), an 'Enable' checkbox (checked), and two radio button options: 'H/W Control Pin (Use DIO 0)' (selected) and 'Activated by Character'. Below these is a 'SW Trigger Character' field with three input boxes, each containing '2B', and a range '(0x00 - 0xFF)'.

Select **H/W Control Pin (Use DIO 0)** to trigger Command Mode by hardware.

#### SW Trigger

The screenshot shows the 'Configuration' page for the NE-4100T-CMD device, identical to the HW Trigger screenshot. In this view, the 'Activated by Character' radio button is selected. The 'SW Trigger Character' field has three input boxes, each containing '2B', which are circled in red. The range '(0x00 - 0xFF)' is also visible.

Select **Activated by Character** to trigger Command Mode by software. In this case, you will also need to enter the three characters (in HEX format) that will be used as the trigger characters.



#### NOTE

1. The default setting is HW Trigger Enabled.
2. Only one of the two trigger types (HW or SW) can be set at the same time.

# Telnet Console

The Telnet Console provides a convenient text-based utility to configure your NE-4100-CMD. Keep in mind that if you are using Telnet to access a Network Enabler connected to the same LAN as your PC, the Network Enabler and PC must be on the same subnet.

1. From the DOS command prompt, type telnet **192.168.127.254** (use the correct IP address if different from the default), and then press enter to access NE-4100-CMD's telnet console.

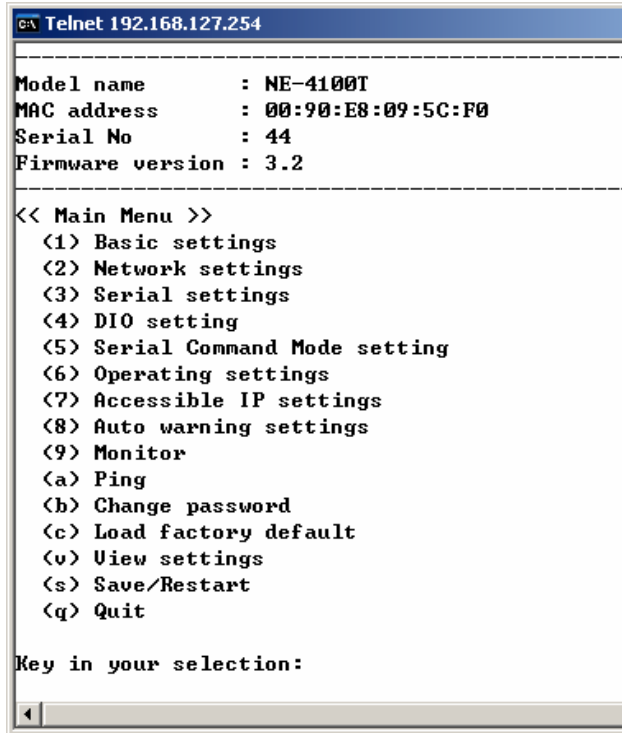

```
C:\> Telnet 192.168.127.254
-----
Model name       : NE-4100T
MAC address      : 00:90:E8:09:5C:F0
Serial No        : 44
Firmware version : 3.2
-----
<< Main Menu >>
<1> Basic settings
<2> Network settings
<3> Serial settings
<4> DIO setting
<5> Serial Command Mode setting
<6> Operating settings
<7> Accessible IP settings
<8> Auto warning settings
<9> Monitor
<a> Ping
<b> Change password
<c> Load factory default
<v> View settings
<s> Save/Restart
<q> Quit

Key in your selection:
```

2. The Telnet Console is easy to use. To select an option, type the character next to the option and then press **Enter**. For example, type **5** to select **Serial Command Mode** setting.

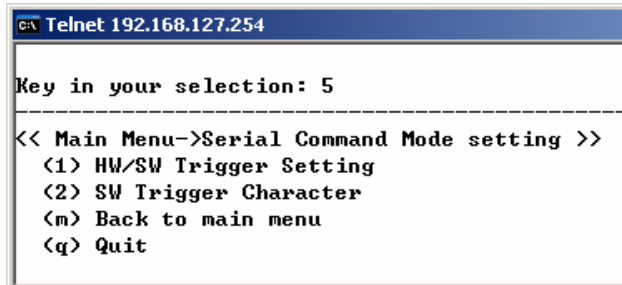

```
C:\> Telnet 192.168.127.254
-----
Key in your selection: 5
-----
<< Main Menu->Serial Command Mode setting >>
<1> HW/SW Trigger Setting
<2> SW Trigger Character
<n> Back to main menu
<q> Quit
```

3. Once all configurations have been made, return to the main Telnet menu, and then type **s** to save the configuration and restart the NE-4100-CMD. If you quit without saving, any changes you made to the configuration will be lost.

# Web Console

The Network Enabler Web Console provides ready access to NE-4100-CMD via web browser. To access the Web Console, open your browser, type the NE-4100-CMD's IP address in the **Address** field (default = 192.168.127.254), and then press **Enter**.

1. The NE-4100-CMD homepage will open.

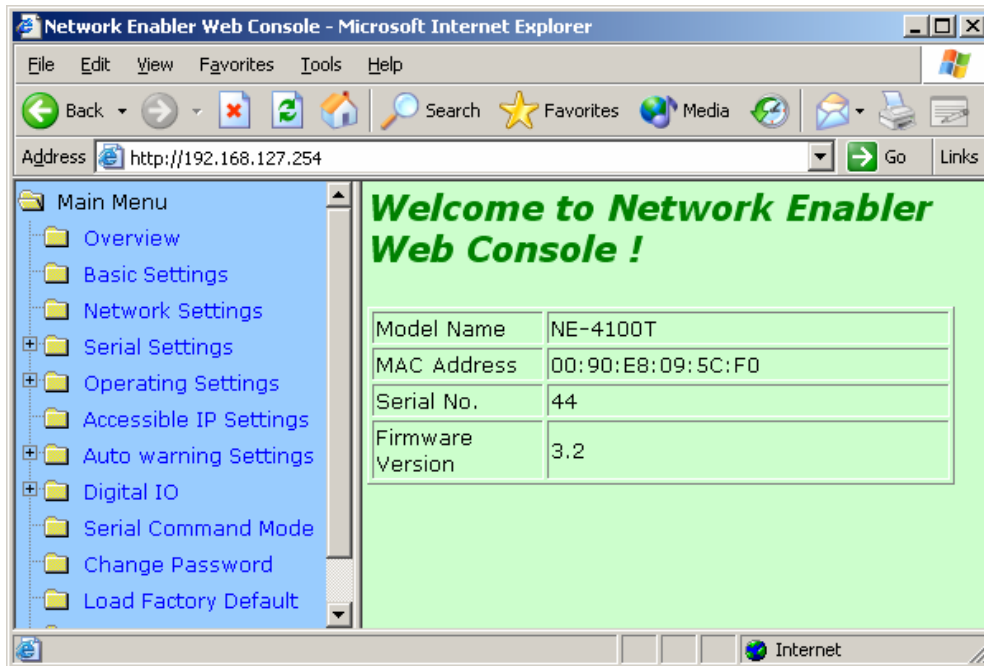

2. Click on the **Serial Command Mode** folder under the left **Main Menu**.

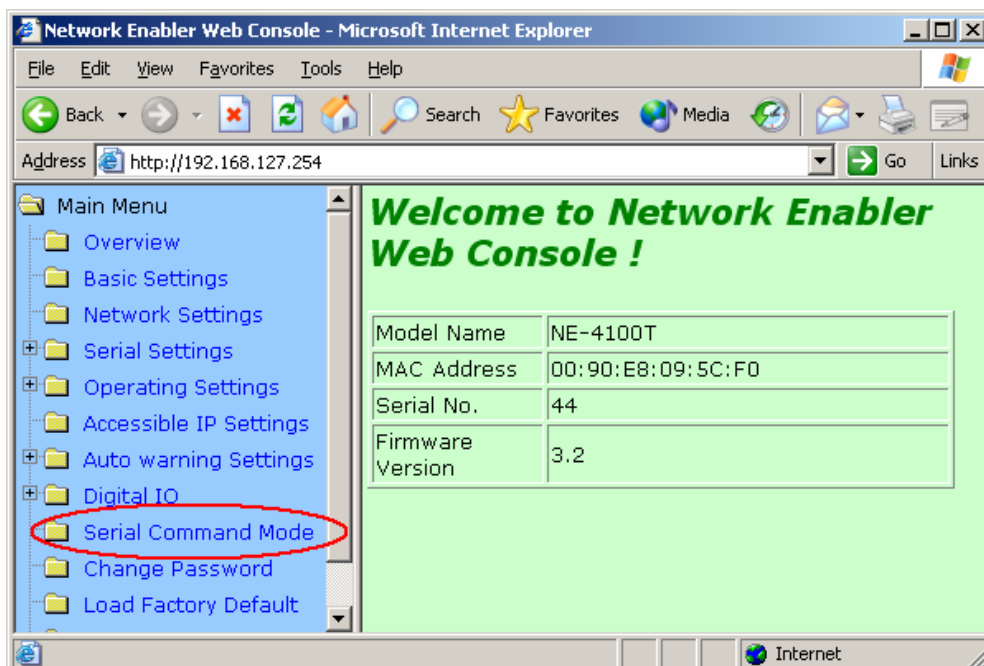

3. Modify the **Trigger Setting** and **SW Trigger Character** as needed, and then click on **Submit**.

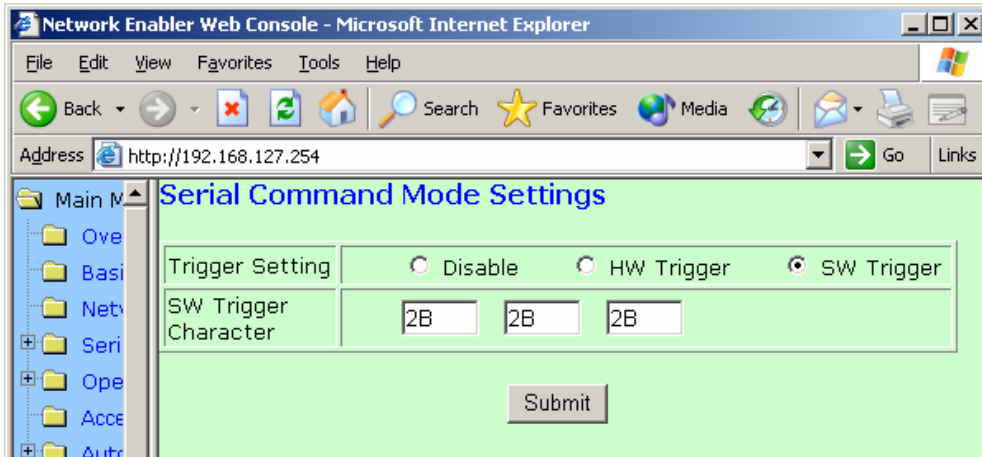

## Serial Console

To access NE-4100-CMD's Serial Console utility, connect the Network Enabler Starter Kit's serial console port (P1) to your PC's serial port, and then use a terminal emulator program (such as Moxa PComm Terminal Emulator) to enter the Console Utility. The serial console port settings are "19200, no, 8, 1". Details of how to connect via the serial console port can be found in the NE-4100 Series User Manual. The text-based configuration utility works exactly the same as if connecting by **Telnet Console**. See the Telnet Console section above for details.

# 5. Entering Serial Command Mode

In this chapter, we explain how to enter Serial Command Mode.

## Trigger Type

There are two types of trigger, HW (Hardware) and SW (Software).

### HW Trigger

- HW Trigger is passed through the GPIO 0 pin.
- Pull GPIO 0 as **low** to trigger (the pin will normally pull high).

Note that the low level trigger must persist for more than 200 ms to qualify as a valid trigger.

### SW Trigger

- The Trigger is activated when 3 user-defined characters are detected.
- See the previous chapter for an explanation of how to configure the SW trigger characters.
  - a. The time interval between characters must be less than 20 ms.
  - b. When the SW Trigger is enabled, the highest achievable data transmission rate will be reduced from 234000 bps to 55000 bps. This is because all data received through serial port 0 will be parsed. In other words, the system must continuously check the serial port data for the SW Trigger characters.

## Serial Port Parameters

The serial port parameters for port P0 can be obtained from Network Enabler Administrator, or Network Enabler Console. For example, from Network Enabler Administrator, open the NE's **Configuration** panel, click on the **Serial** tab, click on the port's information line to highlight it, and then click on **Settings** to open the **Serial Settings** window.

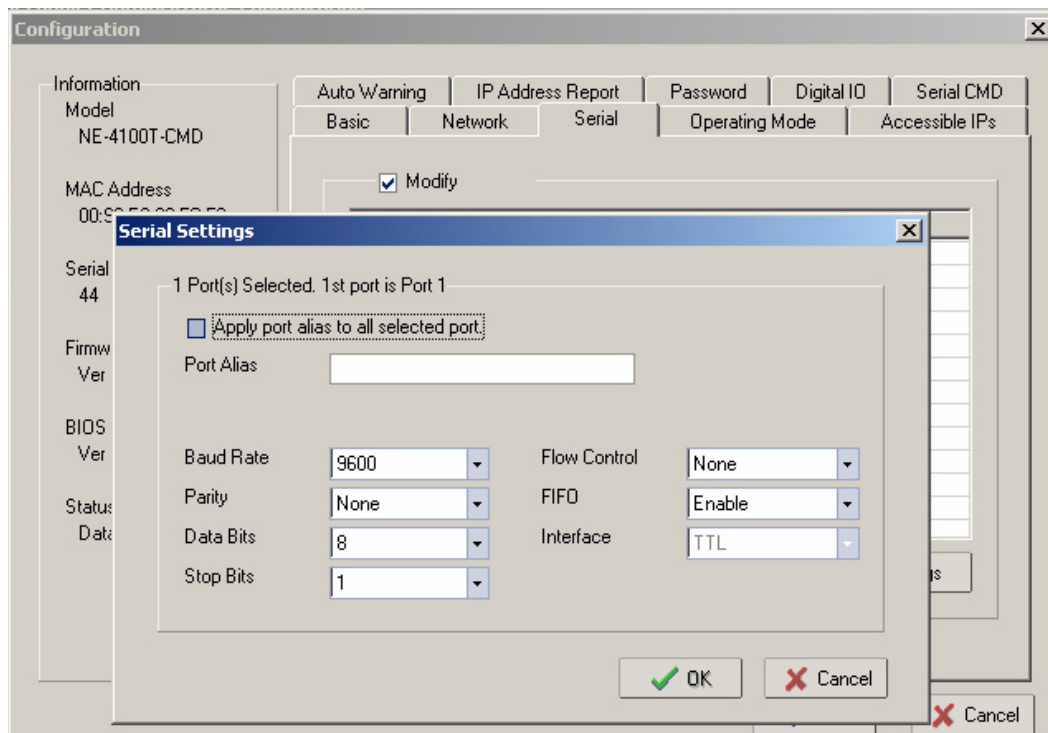

# Comments

1. When entering serial command mode, the string "<E \r" will be sent out from the serial port.
2. All data communication will cease when the device is in serial command mode.
  - Any open TCP connection will be closed, for both the client and the server.
  - No new TCP connections can be established.
  - UDP data communication will be disabled.



## 6. Exiting Serial Command Mode

---

There are three ways to exit Serial Command Mode. All settings made while in command mode will be stored in RAM. After executing **Save / Restart**, the settings will be saved in the flash memory.

### 1. Power Off

Configuration will not take effect after powering back on, since the modifications were not saved.

### 2. Exit by Command (OP Code: BR)

There are two possible exit behaviors

- Save & Restart
- Restart only (modifications will not be saved)

### 3. Auto Restart

If 5 minutes elapses without inputting a valid command, then the NE unit will auto-restart without saving modifications.

# 7. Determining the Active Mode

There are two ways to check if NE-4100-CMD is in Command Mode or Communication Mode.

## By Network Enabler Administrator

Network Enabler Administrator displays clearly the active operation mode in the **Configuration** panel's left **Information** column. In the example shown below, **Status** is listed as **Data Mode**, which indicates normal data transmission.

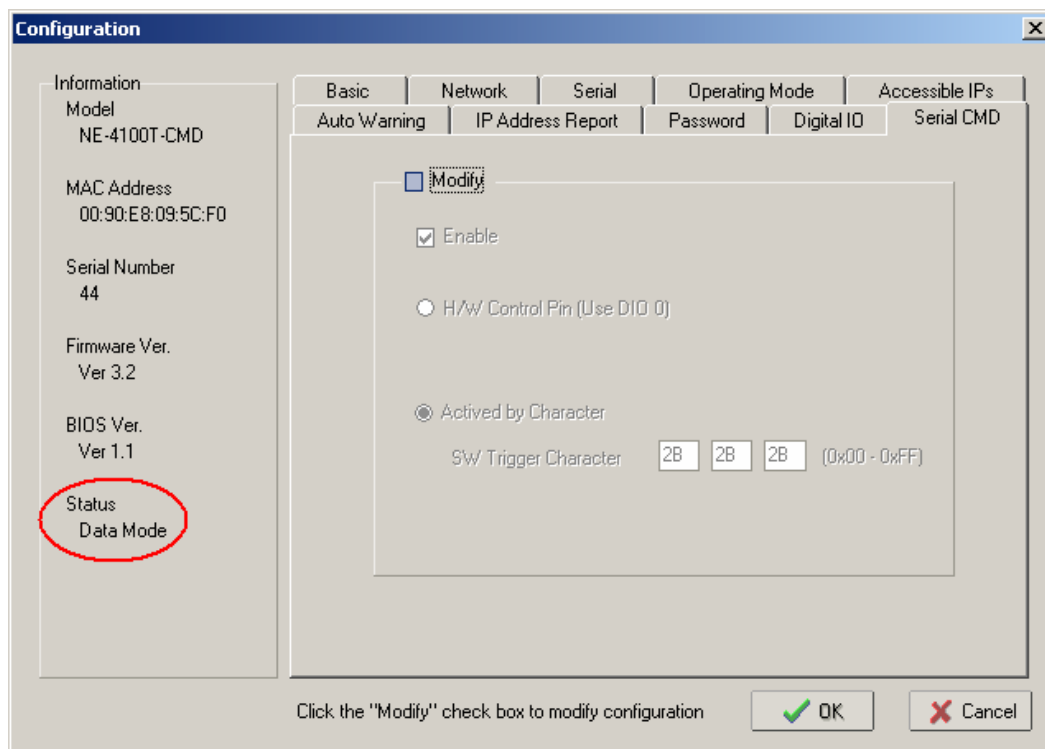

### Data Mode

Data Mode implies normal data transmission. All data communication and configuration functions are activate, and running in full-duplex.

### Command Mode

Command Mode implies that the NE module is being configured. In this case, Ethernet data communication will cease. All data from the serial port will be parsed, and valid commands will be used to change the configuration.

# By Text via the Serial Port

If the NE module is in serial command mode, it will respond with a short message after receiving the serial command end character **0x0d**, allowing the user to send a specific string or character to check if it is in serial command mode.

Serial Device to NE module command	NE Module return code
0x0d (C language: '\r')	0x3c 0x45 0x0d (" <e\r")< td=""></e\r")<>
0x0a, 0x0d (C language: '\n' or Enter key)	0x3c 0x45 0x0d (" <e\r")< td=""></e\r")<>
Error command	0x3c 0x33 0x0c ("<3\r")

# 8. SW Reset Function

Network Enabler Administrator provides an easy way to enable NE-4100-CMD's software reset function. To enable this function, open the NE's **Configuration** page, click on the **Digital IO** tab, and then check the **Enable SW RESET Function (Use DIO 1 on -ST)** checkbox.

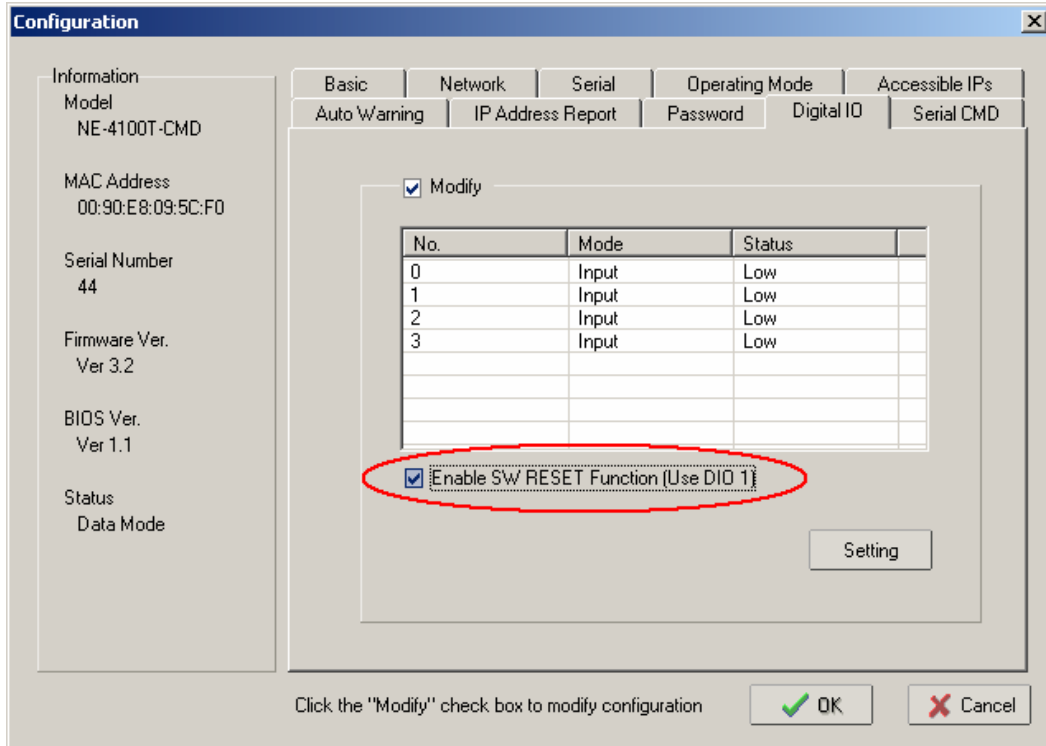

As indicated, the RESET command will be transmitted through GPIO1.

- SW Reset Pin: GPIO 1
- Reset is executed by pulling GPIO 1 low (normal is pulling high)
  - a. Pull 3 sec. to erase the password.
  - b. Pull 10 sec. to load factory defaults.



## NOTE

The SW Reset function is disabled by default. If SW Reset is enabled, then since "disable" is the default, it will be reset to "disabled" automatically after receiving a 10 sec. SW Reset command. This helps to prevent users from resetting to the default values inadvertently.

# 9. Factory Defaults

---

The factory default settings for the **serial port**, **Ethernet port**, **operation mode**, and **trigger method** are given in this chapter.

## Serial Port Defaults

<b>Baud Rate (transmission rate)</b>	9600 bps
<b>Parity</b>	None
<b>Data Bits</b>	8
<b>Stop Bit</b>	1
<b>Flow Control</b>	No
<b>FIFO</b>	Enabled

## Ethernet Port Defaults

<b>IP Configuration</b>	Static
<b>IP Address</b>	192.168.127.254
<b>Netmask</b>	255.255.255.0
<b>Gateway</b>	<i>none</i>

## Default Operation Mode

<b>Operation Mode</b>	TCP Server Mode
-----------------------	-----------------

## Default Trigger Method

<b>Trigger Method</b>	HW Trigger
-----------------------	------------

# 10. Demonstration/Testing Environment

In this chapter, we give four examples that can be used to test the function of NE-4100-CMD. The testing environment is as follows:

## Hardware

- PC that has an RS-232 serial port.
- NE Starter Kit

## Software

- Windows operating system installed on testing PC.
- Network Enabler Administrator (NE Utility; installation program is on the NE software CD).

## Testing Structure

- Ethernet cross-over cable to connect PC's and NE Starter Kit's LAN ports.
- RS-232 cable to connect PC's COM port (usually COM1 or COM2) with NE Starter Kit's serial data port.

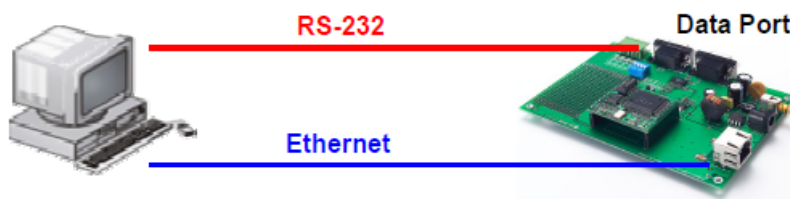

## Example 1: Get Model Name using HW Trigger

- Step 1:** Configure trigger mode to HW trigger (Chap. 4).
- Step 2:** Check NE's serial port settings (Chap. 5).
- Step 3:** Start Windows HyperTerminal and set PC's serial port settings to the same settings recorded in Step 2.
- Step 4:** Pull NE's GPIO 0 to Low to enter Serial Command Mode.
- Step 5:** HyperTerminal displays "<E" (indicates NE is in Serial Command Mode).
- Step 6:** Use HyperTerminal to send ">RBN\n" (command to request NE's Model Name).
- Step 7:** HyperTerminal displays "<YBNNE-4100-CMD\r" (indicates NE's Model Name = NE-4100T-CMD).
- Step 8:** Use HyperTerminal to send ">WBR1\n" (command to exit Serial Command Mode).



## NOTE

When using MOXA PComm Terminal, instead of HyperTerminal, use "CR" (carriage return) in place of "Enter".

## Example 2: Change IP Address using HW Trigger

- Step 1:** Configure trigger mode to HW trigger (Chap. 4).
- Step 2:** Check NE's serial port settings (Chap. 5).
- Step 3:** Start Windows HyperTerminal and set PC's serial port settings to the same settings recorded in Step 2.
- Step 4:** Pull NE's GPIO 0 to Low to enter Serial Command Mode.
- Step 5:** HyperTerminal displays "<E" (indicates NE is in Serial Command Mode).
- Step 6:** Use HyperTerminal to send ">WNP192.168.127.253\n" (set IP address to 192.168.127.253).
- Step 7:** HyperTerminal displays "<YNP\r" (indicates command was executed successfully).
- Step 8:** Use HyperTerminal to send ">WBR2\n" (saves changes and restarts NE Module).
- Step 9:** Repeat Step 1 to Step 5.
- Step 10:** Use HyperTerminal to send ">RNP\n" (command to request NE's IP Address).
- Step 11:** HyperTerminal displays "<YNP192.168.127.253\r" (indicates IP address = 192.168.127.253).
- Step 12:** Use HyperTerminal to send ">WBR1\n" (command to exit Serial Command Mode).



### NOTE

When using MOXA PComm Terminal, instead of HyperTerminal, use "CR" (carriage return) in place of "Enter".

## Example 3: Get IP Mode using SW Trigger

- Step 1:** Configure trigger mode to SW trigger, and check the three trigger characters. For this example, assume the trigger is "2B 2B 2B" (Chap. 4).
- Step 2:** Check NE's serial port settings (Chap. 5).
- Step 3:** Start Windows HyperTerminal and set PC's serial port settings to the same settings recorded in Step 2.
- Step 4:** Use HyperTerminal to send the three trigger characters used to enter Serial Command Mode; "2B 2B 2B" in this example.
- Step 5:** HyperTerminal displays "<E" (indicates NE is in Serial Command Mode).
- Step 6:** Use HyperTerminal to send ">RNC\n" (command to request NE's IP Mode).
- Step 7:** HyperTerminal displays "<YNC1\r" (indicates NE's IP Mode = DHCP).
- Step 8:** Use HyperTerminal to send ">WBR0\n" (command to exit Serial Command Mode).



### NOTE

When using MOXA PComm Terminal, instead of HyperTerminal, use "CR" (carriage return) in place of "Enter".

## Example 4: Change TCP Port Number using SW Trigger

- Step 1:** Configure trigger mode to SW trigger, and check the three trigger characters. For this example, assume the trigger is "2B 2B 2B" (Chap. 4).
- Step 2:** Check NE's serial port settings (Chap. 5).
- Step 3:** Start Windows HyperTerminal and set PC's serial port settings to the same settings recorded in Step 2.
- Step 4:** Use HyperTerminal to send the three trigger characters used to enter Serial Command Mode; "2B 2B 2B" in this example.
- Step 5:** HyperTerminal displays "<E" (indicates NE is in Serial Command Mode).
- Step 6:** Use HyperTerminal to send ">WTL4001\n" (sets TCP Server Port No. = 4001).
- Step 7:** HyperTerminal displays "<YTL\r" (indicates command was executed successfully).
- Step 8:** Use HyperTerminal to send ">WBR2\n" (saves modification and restarts NE module).
- Step 9:** Repeat Step 1 to Step 5.
- Step 10:** Use HyperTerminal to send ">WBR2\n" (saves changes and restarts NE Module).
- Step 11:** HyperTerminal displays "<YTL4001\r" (indicates TCP Server's TCP Port No. = 4001).
- Step 12:** Use HyperTerminal to send ">WBR1\n" (command to exit Serial Command Mode).



### NOTE

When using MOXA PComm Terminal, instead of HyperTerminal, use "CR" (carriage return) in place of "Enter".